



High output LED pole top area light with IES type V square distribution. Wide and uniform 360 degree pattern ideal for large outdoor areas such as parking lots, corporate parks, and retail settings.

Color: White

Weight: 35.5 lbs

Project:	Type:
Prepared By:	Date:

Driver Info		LED Info	
Type:	Constant Current	Watts:	78W
120V:	0.60A	Color Temp:	4000K
208V:	0.372A	Color Accuracy:	73 CRI
240V:	0.322A	L70 Lifespan:	100000
277V:	0.276A	Lumens:	8,183
Input Watts:	72W	Efficacy:	114 LPW
Efficiency:	N/A		

Technical Specifications

Listings

UL Listing:

Suitable for wet locations.

DLC Listed:

This product is listed by Design Lights Consortium (DLC) as an ultra-efficient premium product that qualifies for the highest tier of rebates from DLC Member Utilities.

DLC Product Code: P9KFA9GA

Dark Sky Approved:

The International Dark Sky Association has approved this product as a full cutoff, fully shielded luminaire.

IESNA LM-79 & LM-80 Testing:

RAB LED luminaires have been tested by an independent laboratory in accordance with IESNA LM-79 and LM-80, and have received the Department of Energy "Lighting Facts" label.

LED Characteristics

LEDs:

Long-life, high-efficiency surface mount LEDs

Lifespan:

100,000-hour LED lifespan based on IES LM-80 results and TM-21 calculations.

Color Consistency:

7-step MacAdam Ellipse binning to achieve consistent fixture-to-fixture color.

Color Stability:

LED color temperature is warranted to shift no more than 200K in CCT over a 5 year period.

Color Uniformity:

RAB's range of CCT (Correlated Color Temperature) follows the guidelines of the American National Standard for Specifications for the Chromaticity of Solid State Lighting (SSL) Products, ANSI C78.377-2011.

Electrical

Driver:

Constant Current, Class 2 with 4kV surge protection, 120-277VAC, 50/60 Hz, 120V: 0.60A, 208V: 0.372A, 240V: 0.322A, 277V: 0.276A

THD:

7.8% at 120V, 14.5% at 277V

Power Factor:

99.5% at 120V, 92.4% at 277V

ALED5S78 with Dimmable Drive:

Driver includes dimming control for 0-10V dimming systems. Requires separate 0-10V DC dimming circuit. Dims as low as 10%.

Optical

BUG Rating:

B3 U1 G2

Optics:

Square, Type V distribution

Construction

Cold Weather Starting:

Minimum starting temperature is -40°F / -40°C

Maximum Ambient Temperature:

Suitable for use in 40°C (104°F) ambient temperatures

Thermal Management:

Superior thermal management with external air-flow fins

For use on LEED Buildings:

IDA Dark Sky Approval means that this fixture can be used to achieve LEED Credits for Light Pollution Reduction.

Effective Projected Area:

EPA = 0.7

Housing:

Precision die-cast aluminum

Lens:

Clear polycarbonate

Reflector:

Vacuum-metallized polycarbonate

Gaskets:

High-temperature silicone

Mounting:

Tenon for 2 3/8" or 3" OD post or pole-top adaptor

Finish:

Our environmentally friendly polyester powder coatings are formulated for high-durability and long-lasting color, and contains no VOC or toxic heavy metals.

Technical Specifications (continued)

Construction

Green Technology:

Mercury and UV free. RoHS compliant components. Polyester powder coat finish formulated without the use of VOC or toxic heavy metals.

Other

Replacement:

78 Watt ALED5S replaces 150 Watt Pulse MH / 250 Watt Probe MH.

Patents:

The designs of the ALED5S are protected by patents pending in US, Canada, China, Taiwan and Mexico.

Country of Origin:

Designed by RAB in New Jersey and assembled in the USA by RAB's IBEW Local 3 workers.

Buy American Act Compliant:

This product is a COTS item manufactured in the United States, and is compliant with the Buy American Act.

Recovery Act (ARRA) Compliant:

This product complies with the 52.225-21 "Required Use of American Iron, Steel, and Manufactured Goods-- Buy American Act-- Construction Materials (October 2010).

Trade Agreements Act Compliant:

This product is a COTS item manufactured in the United States, and is compliant with the Trade Agreements Act.

GSA Schedule:

Suitable in accordance with FAR Subpart 25.4.

Dimensions

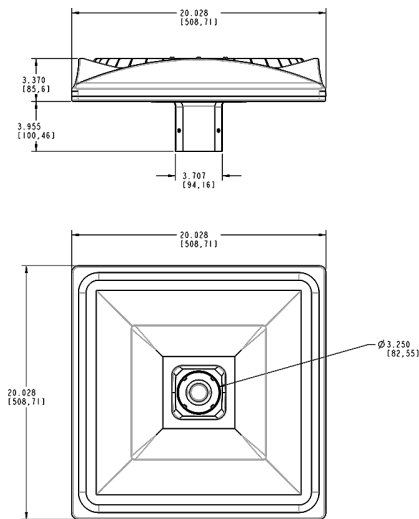

Features

- Precision optics deliver uniform, optimal light distribution
- Perfect for parking lots and pathways
- 100,000-Hour LED lifespan

Ordering Matrix

Family	Distribution	Shape	Watts	Color Temp	Finish	Voltage	Dimming	Bi-Level	Photocell	Pin	Sensor
ALED	5	S	78	N	W		/D10			/7PR	
	5 = Type V	S = Square	78 = 78W 150 = 150W	Blank = 5000K (Cool) N = 4000K (Neutral) Y = 3000K (Warm)	Blank = Bronze W = White	Blank = 120-277V /480 = 480V	Blank = No Dimming /D10 = Dimmable	Blank = No Bi-Level /BL = Bi-Level	Blank = No Photocell /PCT = 120-277V Twistlock Photocell	Blank = No Pin /5PR = 5 Pin Receptacle /7PR = 7 Pin Receptacle	Blank = No Sensor /WS2 = Multi-Level Motion Sensor