

Type II distribution Area Light with wall mount. Fixed mounting @ 90° to wall. Drilling 2" on center. Factory wired for 277V. Lamp supplied.

Color: Bronze

Weight: 37.2 lbs

Project:

Type:

Prepared By:

Date:

Lamp Info

Type: ED28
 Watts: 350W
 Shape/Size: N/A
 Base: N/A
 ANSI: N/A
 Hours: 20,000
 Lamp Lumens: 33,300
 Efficacy: 83 LPW

Ballast Info

Type: CWA HPF QT
 120V: 3.3/3.6A
 208V: N/A
 240V: N/A
 277V: N/A
 Input Watts: 400W
 Efficiency: 88%

Technical Specifications

Listings

UL Listing:

Suitable for wet locations. Suitable for mounting within 1.2m (4ft) of the ground.

Dark Sky Approved:

The International Dark Sky Association has approved this product as a full cutoff, fully shielded luminaire.

Electrical

Photocell:

120V Photocell Included. Photocell is only compatible with 120V.

Socket:

Porcelain socket pulse rated 4kv, 1500 watts and 600 volts, reinforced with cat's eyes for added durability. Silicone and fiberglass #14 gauge socket leads rated for 200C. Plated screw shell designed to resist corrosion with spring loaded center contact.

Construction

Lens Gasket:

High temperature extruded silicone set in die cast retaining groove. Remains in place during relamping.

Housing:

One-piece precision die cast aluminum housing and door held captive when opened. Removable hinge pins for door removal.

Reflector:

Hydroformed Type II reflector.

Finish:

Our environmentally friendly polyester powder coatings are formulated for high-durability and long-lasting color, and contains no VOC or toxic heavy metals.

Lens:

Thermal, tempered shock resistant glass, 5/32" thick.

Mounting Arm:

Mounts with two 5/16 -18 threaded rods at 2" on center.

Other

Patents:

Sensor and fixture designs are protected under U.S. and International Intellectual Property Laws.

Country of Origin:

Designed by RAB in New Jersey and assembled in the USA by RAB's IBEW Local 3 workers.

Buy American Act Compliant:

This product is a COTS item manufactured in the United States, and is compliant with the Buy American Act.

Recovery Act (ARRA) Compliant:

This product complies with the 52.225-21 "Required Use of American Iron, Steel, and Manufactured Goods-- Buy American Act-- Construction Materials (October 2010).

Trade Agreements Act Compliant:

This product is a COTS item manufactured in the United States, and is compliant with the Trade Agreements Act.

GSA Schedule:

Suitable in accordance with FAR Subpart 25.4.

Dimensions

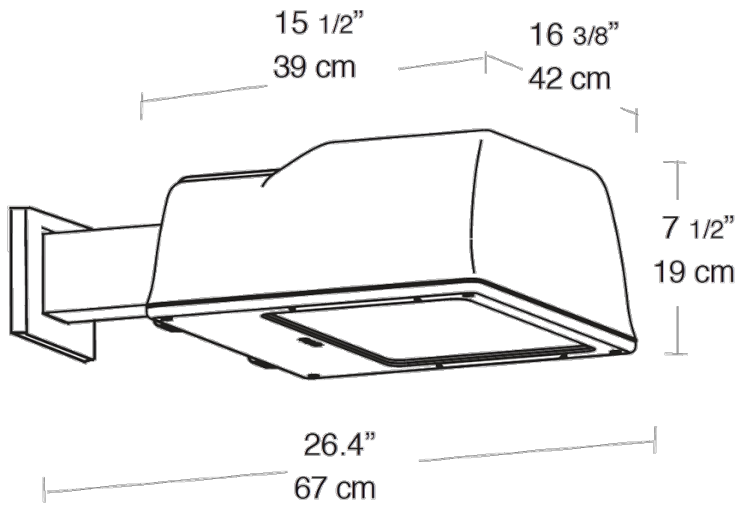

Features

- Fins dissipate heat outside the ballast compartment
- Hydroformed type II reflector for superior optic control
- Capacitor cradle dissipates heat and extends lamp and ballast life
- Stainless steel external hardware
- Fixed arm for pole mounting or slipfitter mount
- Silicone gasket for durable weatherproofing & easy relamping
- Lamp supplied