



<b>Project:</b>	<b>Type:</b>
<b>Prepared By:</b>	<b>Date:</b>

Driver Info		LED Info	
Type	Constant Current	Watts	55W
120V	470	Color Temp	Field Adjustable
208V	N/A	Color Accuracy	N/A
240V	N/A	L70 Lifespan	50,000 Hours
277V	210	Lumens	5,000
Input Watts	55W	Efficacy	90.9 lm/W

## Technical Specifications

### Other

#### Product Type:

Commercial Downlight Direct Mount

#### Warranty:

RAB warrants that our LED products will be free from defects in materials and workmanship for a period of five (5) years from the date of delivery to the end user, including coverage of light output, color stability, driver performance and fixture finish. RAB's warranty is subject to all terms and conditions found at [rablighting.com/warranty](http://rablighting.com/warranty).

#### Buy American Act Compliance:

RAB values USA manufacturing! Upon request, RAB may be able to manufacture this product to be compliant with the Buy American Act (BAA). Please contact customer service to request a quote for the product to be made BAA compliant.

### Performance

#### Typical Lumen Output:

5000

#### Efficacy:

91 lm/W

#### Color Accuracy:

90 CRI

#### Color Temperature:

3000K | 3500K | 4000K | 5000K

#### Lifespan:

50,000-Hour LED lifespan based on IES LM-80 results and TM-21 calculations

### Electrical

#### THD:

≤20%

#### Power Factor:

≥0.9

#### Dimmable:

Driver includes dimming control for 0-10V dimming systems. Requires separate 0-10V DC dimming circuit. Dims down to 10%.

#### Input Voltage:

120-277V

#### Operating Frequency:

50/60Hz

#### Operating Temperature:

-30°C - 40°C

## Technical Specifications (continued)

### Construction

**Size:**

8"

**Shape:**

Round

**Housing Material:**

Metal

**Finish:**

White

**Trim Style:**

Smooth Trim

**Air Tight:**

Housing certified Air Tight as per ASTM E283

**Compliance****Safety Listing:**

UL Listed, UL Classified

**Environment:**

Wet

**T24 JA8 Compliant:**

Complies with Title 24 Appendix JA8

**Lawful for Sale in California:**

Yes

**RoHS:**

Mercury and UV free. RoHS-compliant components.

**FCC:**

Complies with Part 15 of the FCC Rules

**Model Number:**

DLC0052(C8R559FAUNVW)

## Dimensions

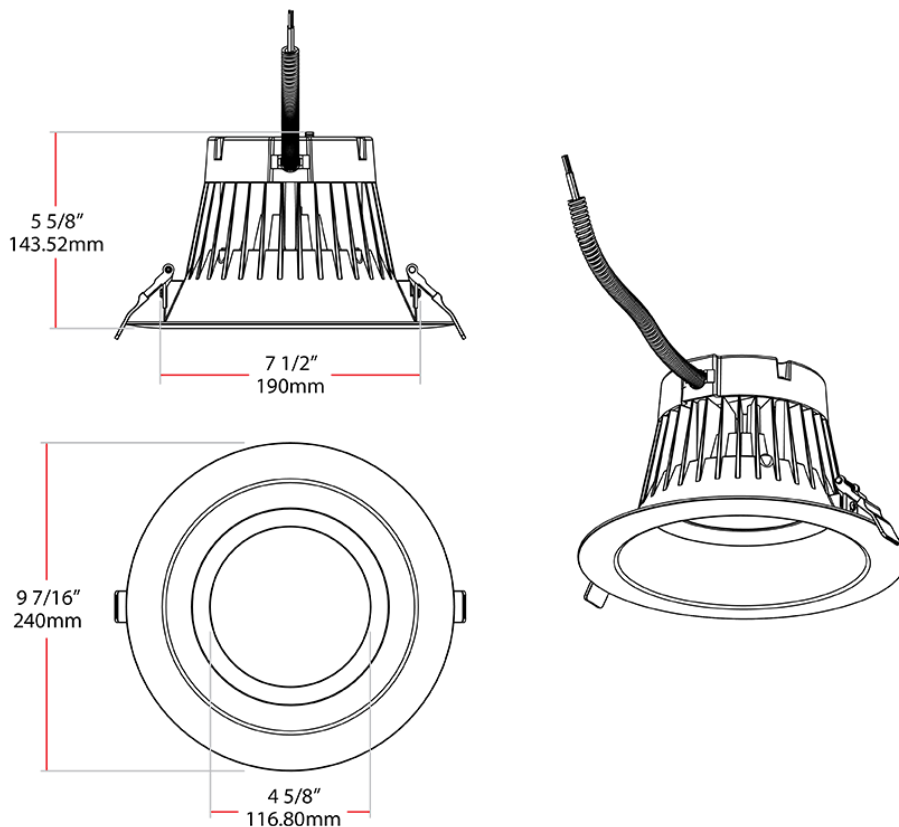

## Ordering Matrix

Family	Size	Shape	Wattage	CRI/Color Temp	Voltage	Finish
C	8	R	55	9FA	UNV	W
	6 = 6" 8 = 8"	R = Round	11 = 11W 18 = 18W 22 = 22W 33 = 33W 55 = 55W	9FA = 90 CRI, Field Adjustable	UNV = 120-277V	W = White