



Precision 6H x 4V optics make this 78 Watt slipfitter floodlight a great choice for illuminating large signs and building facades.

Color: Bronze

Weight: 26.6 lbs

Project:	Type:
Prepared By:	Date:

Driver Info		LED Info	
Type:	Constant Current	Watts:	78W
120V:	N/A	Color Temp:	4000K
208V:	0.53A	Color Accuracy:	82 CRI
240V:	0.46A	L70 Lifespan:	100000
277V:	0.40A	Lumens:	6,828
Input Watts:	90W	Efficacy:	76 LPW
Efficiency:	87%		

Technical Specifications

Electrical

Photocell:

277V Button Photocell Included. Photocell is compatible with 208V-277V.

Drivers:

Constant current, Class 2, 100-277V, 50/60 Hz, 6kV Surge Protection, 720mA, 100-277V: 0.4A, THD <20%, Power Factor 89.7%

THD:

13.9% at 120V

Listings

UL Listing:

Suitable for wet locations. Suitable for ground mounting.

IESNA LM-79 & LM-80 Testing:

RAB LED luminaires have been tested by an independent laboratory in accordance with IESNA LM-79 and LM-80, and have received the Department of Energy "Lighting Facts" label.

Construction

IP Rating:

Ingress Protection rating of IP66 for dust and water

Effective Projected Area:

EPA = 1.2

Cold Weather Starting:

Minimum starting temperature is -40°F/-40°C

Ambient Temperature:

Suitable for use in 40°C (104°F) ambient temperatures

Thermal Management:

Superior thermal management with external Air-Flow fins

Housing:

Precision die-cast aluminum housing and door frame

Mounting:

2 3/8" slipfitter mount with stainless steel hardware

Lens:

Microprismatic diffusion lens for smooth and even light distribution

Reflector:

Vacuum-metalized, specular polycarbonate

Gaskets:

High-temperature silicone

Finish:

Our environmentally friendly polyester powder coatings are formulated for high-durability and long-lasting color, and contains no VOC or toxic heavy metals.

Green Technology:

Mercury and UV free. RoHS compliant components. Polyester powder coat finish formulated without the use of VOC or toxic heavy metals.

LED Characteristics

LEDs:

Multi-chip, high-output, long-life LEDs

Lifespan:

100,000-hour LED lifespan based on IES LM-80 results and TM-21 calculations.

Color Consistency:

3-step MacAdam Ellipse binning to achieve consistent fixture-to-fixture color.

Color Stability:

LED color temperature is warranted to shift no more than 200K in CCT over a 5 year period.

Color Uniformity:

RAB's range of CCT (Correlated Color Temperature) follows the guidelines of the American National Standard for Specifications for the Chromaticity of Solid State Lighting (SSL) Products, ANSI C78.377-2011.

Optical

NEMA Type:

NEMA Beam Spread of 6H x 4V

Replacement:

The CANVAS78 replaces 250W MH floodlights.

Other

California Title 24:

CANVAS78SF/PC2 complies with 2013 California Title 24 building and electrical codes as a commercial outdoor pole-mounted fixture > 30 Watts mounted at height greater than 24 feet. For mounting heights < 24 feet see CANVAS78SF/BL with bi-level operation; additional component requirements will be listed in the Title 24 section under technical specifications on the product page.

Patents:

The design of CANVAS is protected by pending patents in U.S., Canada, China, Taiwan and Mexico.

Technical Specifications (continued)

Other

Country of Origin:

Designed by RAB in New Jersey and assembled in the USA by RAB's IBEW Local 3 workers.

Buy American Act Compliant:

This product is a COTS item manufactured in the United States, and is compliant with the Buy American Act.

Recovery Act (ARRA) Compliant:

This product complies with the 52.225-21 "Required Use of American Iron, Steel, and Manufactured Goods-- Buy American Act-- Construction Materials (October 2010).

Trade Agreements Act Compliant:

This product is a COTS item manufactured in the United States, and is compliant with the Trade Agreements Act.

GSA Schedule:

Suitable in accordance with FAR Subpart 25.4.

Dimensions

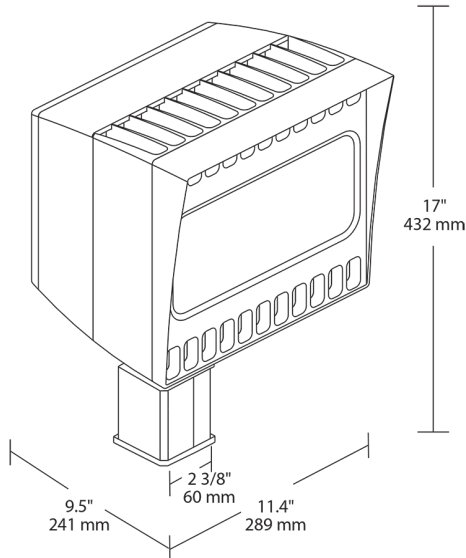

Features

- Replaces 250W MH Floodlights
- NEMA Type 6H x 4V ideal for signage & facades
- Ultra-low field-to-beam ratio concentrates light where it's required
- Microprismatic diffusion lens optimizes light output without glare
- Superior thermal management with patent-pending "Airflow" technology
- 100,000-Hour LED lifespan

Ordering Matrix

Family	Watts	Mount	Color Temp	Finish	Photocell	Bi-Level
CANVAS	78 = 78W	SF = Slipfitter	Blank = 5000K (Cool) Y = 3000K (Warm) N = 4000K (Neutral)	Blank = Bronze W = White	Blank = No Photocell /PC = 120V Button /PCS = 120V Swivel /PC2 = 277V Button /PCS2 = 277V Swivel	Blank = No Bi-Level /BL = Bi-Level