



High performance ceiling mounted LED lighting with mini sensor. Bi-level option available. Flush mount fixture bracket.

Color: White

Weight: 12.2 lbs

Project:	Type:
Prepared By:	Date:

Driver Info		LED Info	
Type:	Constant Current	Watts:	40W
120V:	0.38A	Color Temp:	5000K
208V:	N/A	Color Accuracy:	69 CRI
240V:	N/A	L70 Lifespan:	100000
277V:	N/A	Lumens:	2,746
Input Watts:	43W	Efficacy:	65 LPW
Efficiency:	94%		

Technical Specifications

Listings

UL Listing:

Suitable for damp locations.

IESNA LM-79 & IESNA LM-80 Testing:

RAB LED luminaires have been tested by an independent laboratory in accordance with IESNA LM-79 and LM-80, and have received the Department of Energy "Lighting Facts" label.

LED Characteristics

Lifespan:

100,000-hour LED lifespan based on IES LM-80 results and TM-21 calculations.

LEDs:

(4) 10W Multi-chip high-output, long-life LED.

Color Consistency:

7-step MacAdam Ellipse binning to achieve consistent fixture-to-fixture color.

Color Stability:

LED color temperature is warranted to shift no more than 200K in CCT over a 5 year period.

Color Uniformity:

RAB's range of CCT (Correlated color temperature) follows the guidelines of the American National Standard for Specifications for the Chromaticity of Solid State Lighting (SSL) Products, ANSI C78.377-2011.

Color Accuracy:

66 CRI

Color Temperature (Nominal CCT):

5000K

Construction

Recommended Mounting Height:

8-10'.

Cold Weather Starting:

Minimum starting temperature is -40°F/-40°C.

Housing:

Precision die cast aluminum housing and lens framing.

Gaskets:

High-temperature silicone

Finish:

Our environmentally friendly polyester powder coatings are formulated for high-durability and long-lasting color, and contains no VOC or toxic heavy metals.

Green Technology:

Mercury and UV free. RoHS compliant components. Polyester powder coat finish formulated without the use of VOC or toxic heavy metals.

Electrical

Drivers (2):

Constant Current, Class 2, 100V-277V, 50/60 Hz, 4kv Surge Protection, 1000mA, 100-240VAC 0.5Amps, 277VAC 0.25Amps, Power Factor 98.4%.

THD:

6.5% at 120V

Voltage:

120 volts AC 60 Hz.

Other

Thermal Management (Patent Pending):

Die-cast aluminum Thermal Management system for optimal heat dissipation.

Patents:

RAB CLED2X20 are protected by patents in US pat. D634,872 CN ZL201030129122 MX 32490 TW pat. D139372

Warranty:

RAB warrants that our LED products will be free from defects in materials and workmanship for a period of five (5) years from the date of delivery to the end user, including coverage of light output, color stability, driver performance and fixture finish.

California Title 24:

CLED complies with California Title 24 building and electrical codes.

Equivalency:

The CLED2X20MS is equivalent in delivered lumens to a 100W MH Ceiling Fixture.

HID Replacement Range:

The CLED2X20MS can be used to replace 100-150W Metal Halide Ceiling Lights based on delivered lumens.

Country of Origin:

Designed by RAB in New Jersey and assembled in the USA by RAB's IBEW Local 3 workers.

Buy American Act Compliant:

This product is a COTS item manufactured in the United States, and is compliant with the Buy American Act.

Technical Specifications (continued)

Other

Recovery Act (ARRA) Compliant:

This product complies with the 52.225-21 "Required Use of American Iron, Steel, and Manufactured Goods-- Buy American Act-- Construction Materials (October 2010).

Trade Agreements Act Compliant:

This product is a COTS item manufactured in the United States, and is compliant with the Trade Agreements Act.

GSA Schedule:

Suitable in accordance with FAR Subpart 25.4.

Optical

Fixture Efficacy:

65 Lumens per Watt

BUG Rating:

B1 U1 G0

Sensor Characteristics

Sensor Switching Capacity:

5 Amps, 450 Watts LED @ 120 Volts 0.8pF Driver; 5 Amps, 300 Watts LED @ 120 Volts 0.5pF Driver.

Sensor Time Adjustment:

5 seconds to 15 minutes.

Sensor Quick Test Time:

5 second test time for fast installation. Works day or night.

Sensor "No Hands" Auto Testing:

Auto mode starts after 4 minutes of testing. No adjustment needed.

Sensor Photoelectric Control:

Deactivates lights during daylight. Fully adjustable for 24 hour operation or custom applications.

Sensor LED Detection Indicator:

LED glows red day & night for "on guard" deterrence.

Sensor RF Immunity:

Circuits fully shielded for maximum radio frequency immunity.

Sensor Ratings:

5 amps.

Sensor Power Consumption:

Negligible

Sensor Manual Switch:

None.

Sensor Ambient Light Sensing:

Adjustable.

Sensor Adjustments:

Time, ambient light & sensitivity.

Sensor Detection:

360° detection pattern.

Dimensions

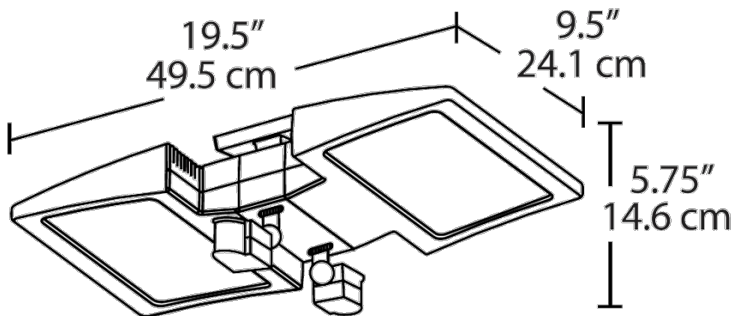

Features

- Reduce energy usage with motion sensor technology you can rely on
- LED combined with mini sensor for an all-in-one lighting solution
- Great for small spaces like utility closets and storage rooms
- 5 year warranty