



Now, more is less. Economical retrofit downlights with more to offer. Available in standard or adjustable heads.

Color: White

Weight: 0.8 lbs

Project:

Type:

Prepared By:

Date:

Driver Info

Type: Constant Current
 120V: 0.078A
 208V: N/A
 240V: N/A
 277V: N/A
 Input Watts: 9W
 Efficiency: N/A

LED Info

Watts: 9W
 Color Temp: 3500K
 Color Accuracy: 91 CRI
 L70 Lifespan: 100000
 Lumens: 786
 Efficacy: 87 LPW

Technical Specifications

Listings

UL Listing:

Suitable for damp locations

ENERGY STAR® V2.0:

This product is ENERGY STAR® Version 2.0 Certified.

IESNA LM-79 & IESNA LM-80 Testing:

RAB LED luminaires have been tested by an independent laboratory in accordance with IESNA LM-79 and 80, and have received the Department of Energy "Lighting Facts" label.

Electrical

Driver:

Constant Current, Class 2, 50/60 Hz, 120V: 0.078A

Dimming:

TRIAC, ELV and 0-10V dimming compatibility.

THD:

26.21% at 120V

Power Factor:

95.7% at 120V

LED Characteristics

LEDs:

Multi-chip, high-output, long-life LEDs

Lifespan:

50,000-hour LED lifespan based on IES LM-80 results and TM-21 calculations.

Construction

Housing:

Precision, die-cast aluminum

Installation:

Torsion springs for secure installation

Socket Adapter:

Edison 26 Medium Base Socket adapter

Lens:

Frosted acrylic lens

Finish:

Chip and fade resistant polyester powder coat finish

Green Technology:

Mercury and UV free. RoHS compliant components.

Other

Warranty:

RAB warrants that our LED products will be free from defects in materials and workmanship for a period of five (5) years from the date of delivery to the end user, including coverage of light output, color stability, driver performance and fixture finish.

Dimensions

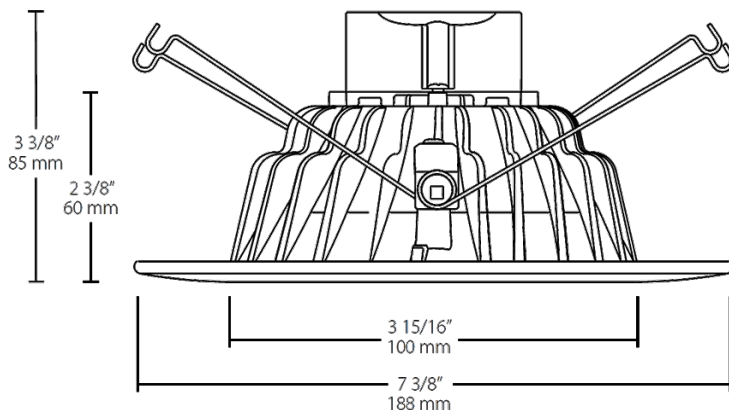

Features

- Superior thermal management with heat-dissipating fins
- Specification-grade 90 CRI standard
- Edison E26 Medium Base socket adapter included
- 5 year no compromise warranty

Ordering Matrix

Family	Color Temp	Size	Type	Shape	Watts
DLED	DLED	6		R	9
	Y = 3000K (Warm)	4 = 4"	Blank = Standard	R = Round	9 = 9W
	YY = 2700K (Residential Warm)	6 = 6"	A = Adjustable (11W in 4" & 14W in 6" only)		11 = 11W
	YN = 3500K (Warm Neutral)				14 = 14W