

LED retrofit downlights are perfect for updating existing recessed lighting without changing the fixture. Equivalent to xxW Par.

Color: White

Weight: 4.2 lbs

**Project:**

**Type:**

**Prepared By:**

**Date:**

### Driver Info

Type	Constant Current
120V	0.31A
208V	0.19A
240V	0.17A
277V	0.14A
Input Watts	38.00W
Efficiency	N/A

### LED Info

Watts	38.00W
Color Temp	3000K (Warm)
Color Accuracy	82 CRI
L70 Lifespan	100,000
Lumens	N/A
Efficacy	0 LPW

## Technical Specifications

### Listings

#### UL Listed:

Suitable for damp locations; non-IC-rated ceilings

#### IESNA LM-79 & LM-80 Testing:

RAB LED luminaires and LED components have been tested by an independent laboratory in accordance with IESNA LM-79 and LM-80.

### Electrical

#### Driver:

Class 2, Constant Current, 50-60Hz, 900mA

#### Dimming:

Universal dimming driver for 0-10V (at 120-277V), TRIAC or ELV (at 120V only). [See dimmer compatibility guide here.](#)

#### Surge Protection:

6kV

### Construction

#### Housing Component:

This component must be ordered with Retrofit Downlights Trim Module in order to make a complete fixture.

[See here for Retrofit Reflectors.](#)

#### Cold Weather Starting:

The minimum starting temperature is -30°C (-22°F)

#### Maximum Ambient Temperature:

Suitable for use in 35°C (95°F)

#### Lens:

Microprismatic diffusion lens for smooth and even light distribution

#### Mounting:

Ceiling clamps for easy installation into existing, commercial, recessed downlight frames with opening of 7 7/8" (200mm) minimum and 8 7/8" (225.4mm) maximum (ceiling+can/pan thickness 1 7/16" maximum).

#### Compatibility:

Low-profile design for maximum compatibility with 8" incandescent recessed downlight housings

#### Heat Sink:

Die-cast aluminum with external fins for maximum heat dissipation

#### Finish:

Formulated for high durability and long-lasting color

#### Green Technology:

Mercury and UV free. RoHS-compliant components.

### LED Characteristics

#### Lifespan:

100,000-hour LED lifespan based on IES LM-80 results and TM-21 calculations

#### LEDs:

Long-life, high-efficiency surface mount LEDs with 3 step binning

#### Color Consistency:

3-step MacAdam Ellipse binning to achieve consistent fixture-to-fixture color

### Other

#### Warranty:

RAB warrants that our LED products will be free from defects in materials and workmanship for a period of ten (10) years from the date of delivery to the end user, including coverage of light output, color stability, driver performance and fixture finish. RAB's warranty is subject to all terms and conditions found at [rablighting.com/warranty](http://rablighting.com/warranty).

#### Replacement:

Replaces 70Watt Metal Halide and 42 Watt CFL

## Technical Specifications (continued)

### Other

#### Buy American Act Compliance:

RAB values USA manufacturing! Upon request, RAB may be able to manufacture this product to be compliant with the Buy American Act (BAA). Please contact customer service to request a quote for the product to be made BAA compliant.

### Dimensions

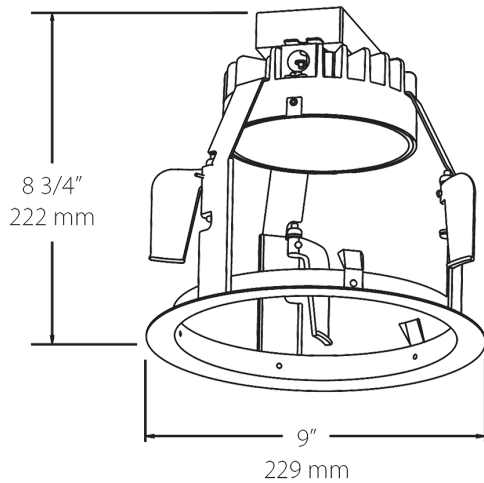

### Features

- Low-profile enables compatibility with 8" housings
- UL Listed for damp locations
- Triac & ELV dimmable
- 10-Year, No-Compromise Warranty

### Ordering Matrix

Family	Size	Shape	Wattage	Color Temp	CRI	Other Options
DLED	8	R	38	Y		
	8 = 8"	R = Round	30 = 30W 38 = 38W	YY = 2700K (Residential Warm) Y = 3000K (Warm) YN = 3500K (Warm Neutral) N = 4000K (Neutral)	Blank = 82 CRI HC = 94 CRI	Blank = Standard USA = BAA Compliant