



Large size flood for easier relamping and glare reduction. Durable one piece die casting with rugged mounting arm, weatherproof gasket and drain holes. Accepts 150 Watt PAR 38 max. Lamp not supplied.

Color: White

Weight: 9.8 lbs

Project:	Type:
Prepared By:	Date:

Lamp Info		Ballast Info	
Type:	PAR38 MH	Type:	HX-HPF QT
Watts:	100W	120V:	1.0/1.2A
Shape/Size:	PAR38	208V:	.6/.7A
Base:	Med	240V:	.5/.6A
ANSI:	M90	277V:	.4/.5A
Hours:	15,000	Input Watts:	129W
Lamp Lumens:	6,800	Efficiency:	78%
Efficacy:	53 LPW		

Technical Specifications

Listings

UL Listing:

Suitable for wet locations. Suitable for ground mounting. Can be aimed above horizontal with accessory hood or visor.

EISA 2007 Compliant:

This product complies with the new law for metal halide ballast efficiency. This law goes into effect January 1st, 2008. Pulse Start offers Longer Lamp Life, Faster Startup and Faster Restrike.

Electrical

Sockets:

4kv pulse rated glazed porcelain with all copper current carrying components. Nickel plated screw shell and spring contacts.

Quad Tap:

Fixture works with 120, 208, 240 and 277 volts.

Construction

Swivels:

Fully adjustable with sure-grip locks. 1/2" NPS threaded arm with serrated locking swivel fits all standard mounting covers. Color matched EZ Grip lock nuts. Stainless steel screw.

Housings:

Die cast aluminum with powder coat finish.

Gaskets:

High temperature silicone rubber extends around both socket and lamp.

Color:

White.

Optical

Lamps:

Medium base PAR-38 MH lamps up to 100 watts with choice of beam spreads available. Lamp not supplied.

Lumens Per Watt:

68

Other

Buy American Act Compliant:

This product is a COTS item manufactured in the United States, and is compliant with the Buy American Act.

Recovery Act (ARRA) Compliant:

This product complies with the 52.225-21 "Required Use of American Iron, Steel, and Manufactured Goods-- Buy American Act-- Construction Materials (October 2010).

Trade Agreements Act Compliant:

This product is a COTS item manufactured in the United States, and is compliant with the Trade Agreements Act.

GSA Schedule:

Suitable in accordance with FAR Subpart 25.4.

Dimensions

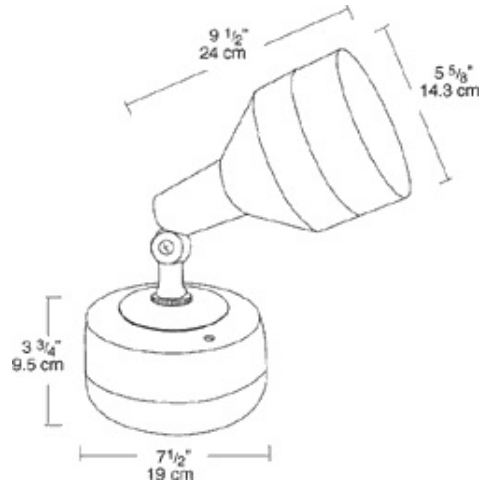

Features

Color may not match product image. Please refer to the specifications below for the correct color

Set screw for hood, grill, or visor attachment

Heavy duty mounting arm with internal O-ring, locking teeth, and stainless steel screw

EZ Grip locknut matches fixture finish and can be adjusted with fingers, pliers or a screwdriver

Rugged die cast aluminum ballast housings with powder coat finish

Side and bottom conduit openings. Close up plugs supplied