



Replace 50 - 400W MH lamps for post tops, low bays, and high bays, in enclosed or open fixtures. 50,000-hour lifespan. Use 76% less energy than MH.

Color: White Weight: 0.5 lbs

Project:	Type:
Prepared By:	Date:

Driver Info		LED Info	
Watts:	12W	Input Voltage:	100-277V
Color Temp:	3000K (Warm White)	Power Factor:	0.9
Lumens:	1,650	Flicker:	<30%
Efficacy:	138 LPW	THDi:	N/A
Color Accuracy:	80 CRI		
L70 Accuracy:	50,000		

Technical Specifications

Listings

UL Listed:

Yes

UL Classified:

Yes

FCC:

Yes

Rohs:

Yes

CEC Status:

Lawful for sale in California

Description

Lamp Type:

HID

Bulb Type:

Post Top

Base Type:

E26, Medium Screw Base

Dimmable:

No

Construction

Operating Temperature:

-20 - 40°C

Bare Lamp Illuminated Length (inches):

1.61"

MOL (inches):

4.92"

MOD (inches):

2.36"

Minimum Compartment Size (inches):

Length: 5.98"
Width: 5.98"
Height: 8.5"

LED Characteristics

Lifespan:

50,000-hour LED lifespan based on IES LM-70 results

Other

Equivalent:

50W HID Post Top

Warranty:

5 years

Optical

Beam Angle:

360°

Shipping Information

Case Qty:

12

Case Dimensions:

12.2 x 9.06 x 7.68

Pallet Quantity of Pieces:

432

Pallet Dimensions:

38.19 x 38.58 x 35.43

Dimensions

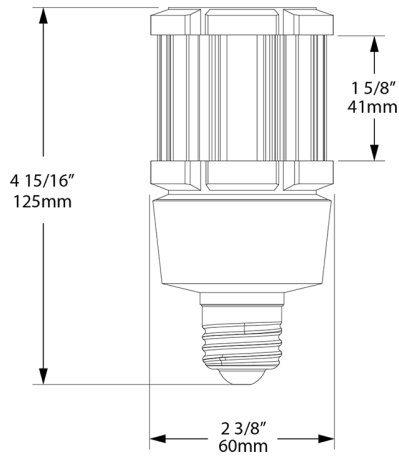

Features

- Replacement for Conventional HID Lamps
- Water and dust resistant - ideal for outdoor fixtures
- Thermal technology extends LED lifetime
- Integrated Heat Sink Quickly Dissipates Heat without onboard fan
- Internal Driver, Eliminates the Need for External Driver or Ballast
- Includes 4kV Surge Protection
- Instantly powers on without warm up time