

product

Compact 4 Watt LED floodlight works with 12V AC lighting systems. Perfectly suited for small-scale landscape lighting applications.

Color: Verde green

Weight: 1.5 lbs

**Project:**

**Type:**

**Prepared By:**

**Date:**

**Driver Info**

Type: Constant Current  
 120V: N/A  
 208V: N/A  
 240V: N/A  
 277V: N/A  
 Input Watts: 5W  
 Efficiency: 86%

**LED Info**

Watts: 4W  
 Color Temp: 4000K  
 Color Accuracy: 82 CRI  
 L70 Lifespan: 100000  
 Lumens: 433  
 Efficacy: 93 LPW

## Technical Specifications

**Listings**

**UL Listing:**

Suitable for wet locations. Suitable for ground mounting.

**Electrical**

**Driver:**

Class 2, 50/60 Hz, 12VAC Max, 0.5A

**Voltage:**

12V AC

**Optical**

**NEMA Type:**

NEMA Beam Spread of 4H x 4V

**Spot Lens:**

Optional spot lens enables a tool-less conversion to a NEMA Type 3H x 3V. Great for accent lighting or grazing buildings for an artistic touch.

**Narrow Spot Lens:**

Optional narrow spot lens enables a tool-less conversion to a NEMA Type 3H x 2V. Great for accent lighting or grazing buildings for an artistic touch.

**Construction**

**Lens:**

Microprismatic diffuser produces a smooth distribution and low glare.

**Cold Weather Starting:**

Minimum starting temperature is -40°F/-40°C.

**Maximum Ambient Temperature:**

Suitable for use in 40°C (104°F) ambient temperatures

**Thermal Management:**

Optimized using computational fluid dynamics software to ensure long LED and driver lifespan.

**Housing:**

Precision die-cast aluminum housing, lens frame and mounting arm.

**Gasket:**

High temperature silicone.

**Finish:**

Our environmentally friendly polyester powder coatings are formulated for high-durability and long-lasting color, and contains no VOC or toxic heavy metals.

**Green Technology:**

Mercury and UV free. RoHS compliant components. Polyester powder coat finish formulated without the use of VOC or toxic heavy metals.

**LED Characteristics**

**Lifespan:**

100,000-hour LED lifespan based on IES LM-80 results and TM-21 calculations

**LED:**

Multi-chip, high-output, long-life LED

**Color Consistency:**

4-step MacAdam Ellipse binning to achieve consistent fixture-to-fixture color.

**Color Stability:**

LED color temperature is warranted to shift no more than 200K in CCT over a 5 year period.

**Color Uniformity:**

RAB's range of CCT (Correlated Color Temperature) follows the guidelines of the American National Standard for (SSL) Products, ANSI C78.377-2015.

**Other**

**Equivalency:**

The LFLED4LV is equivalent in delivered lumens to a 35W MR16.

**Wiring:**

30" SPT1 zip cord included. Transformers provided by others.

**Warranty:**

RAB warrants that our LED products will be free from defects in materials and workmanship for a period of five (5) years from the date of delivery to the end user, including coverage of light output, color stability, driver performance and fixture finish.

**California Title 24:**

LFLED4LV complies with 2013 California Title 24 building and electrical codes as a commercial outdoor non-pole-mounted fixture < 30 Watts when used with a photosensor control. Select catalog number PCS900(120V) or PCS900/277 to order a photosensor.

**Patents:**

The design of the LFLED is protected by Taiwan Patent 01510966 and pending patents in US, Canada, China, and Mexico.

## Dimensions

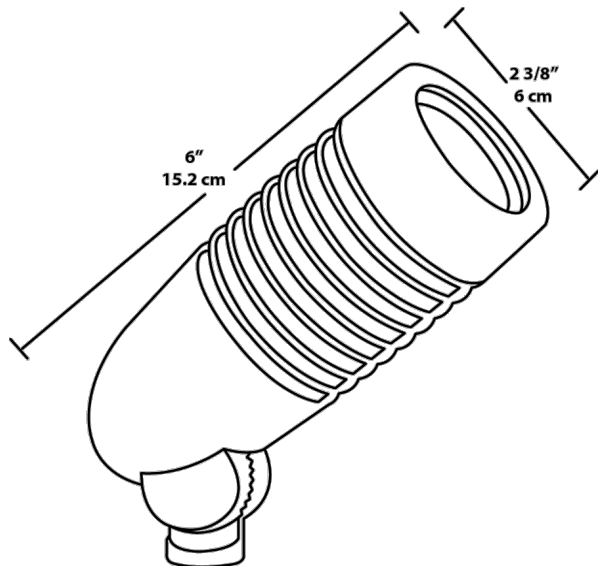

## Features

- Works with existing 12V AC landscape lighting systems
- Replaces 35W MR16 halogen
- Reduces energy consumption by 85%
- Optional spot and narrow spot reflector kits available
- 100,000-Hour LED lifespan

## Ordering Matrix

Family	Watts	Color Temp	Type	Finish
LFLED	4 = 4W	Blank = 5000K (Cool) Y = 3000K (Warm) N = 4000K (Neutral)	LV = Low Voltage	A = Bronze B = Black VG = Verde Green W = White