



Compact 5 Watt LED floodlight perfectly suited for small-scale landscape lighting applications. 85% more energy efficient than its 35 Watt MR16 equivalent. Specialized microprismatic lens delivers even and consistent light. Utilizes line voltage (120V-240V).

Color: Black

Weight: 1.5 lbs

Project:	Type:
Prepared By:	Date:

Driver Info		LED Info	
Type:	Constant Current	Watts:	5W
120V:	0.1A	Color Temp:	4000K
208V:	0.06A	Color Accuracy:	90 CRI
240V:	0.05A	L70 Lifespan:	100000
277V:	N/A	Lumens:	208
Input Watts:	5W	Efficacy:	41 LPW
Efficiency:	99%		

Technical Specifications

Listings

UL Listing:

Suitable for wet locations. Suitable for ground mounting.

IESNA LM-79 & IESNA LM-80 Testing:

RAB LED luminaires have been tested by an independent laboratory in accordance with IESNA LM-79 and 80, and have received the Department of Energy "Lighting Facts" label.

LED Characteristics

Lifespan:

100,000-hour LED lifespan based on IES LM-80 results and TM-21 calculations.

LED:

5 Watt high output, long-life LED.

Color Consistency:

3-step MacAdam Ellipse binning to achieve consistent fixture-to-fixture color.

Color Stability:

LED color temperature is warrantied to shift no more than 200K in CCT over a 5 year period.

Color Accuracy:

90 CRI

Color Temperature (Nominal CCT):

4000K

Color Uniformity:

RAB's range of CCT (Correlated Color Temperature) follows the guidelines of the American National Standard for (SSL) Products, ANSI C78.377-2015.

Optical

Spot Lens:

Optional spot lens enables a tool-less conversion to a NEMA Type 3H x 3V. Great for accent lighting or grazing buildings for an artistic touch.

Fixture Efficacy:

41 Lumens per Watt

NEMA Type:

4H x 4V

Construction

Lens:

Microprismatic diffusion lens for smooth and even light distribution.

Cold Weather Starting:

Minimum starting temperature is -40°F/-40°C.

Maximum Ambient Temperature:

Suitable for use in 40°C (104°F) ambient temperatures

Thermal Management:

Optimized using computational fluid dynamics software to ensure long LED and driver lifespan.

Housing:

Precision die-cast aluminum housing, hood and mounting arm.

Gaskets:

High Temperature Silicone.

Finish:

Our environmentally friendly polyester powder coatings are formulated for high-durability and long-lasting color, and contains no VOC or toxic heavy metals.

Green Technology:

Mercury and UV free. RoHS compliant components. Polyester powder coat finish formulated without the use of VOC or toxic heavy metals.

Electrical

Driver:

Constant Current, Class 2, 100-240V, 50-60Hz, 100-240VAC 0.18A.

Other

Equivalency:

The LFLED5 is equivalent in delivered lumens to a 35W MR16.

Warranty:

RAB warrants that our LED products will be free from defects in materials and workmanship for a period of five (5) years from the date of delivery to the end user, including coverage of light output, color stability, driver performance and fixture finish.

California Title 24:

LFLED5 complies with 2013 California Title 24 building and electrical codes as a commercial outdoor non-pole-mounted fixture < 30 Watts when used with a photosensor control. Select catalog number PCS900(120V) or PCS900/277 to order a photosensor.

Patents:

The design of the LFLED is protected by Taiwan Patent 01510966 and pending patents in US, Canada, China, and Mexico.

Dimensions

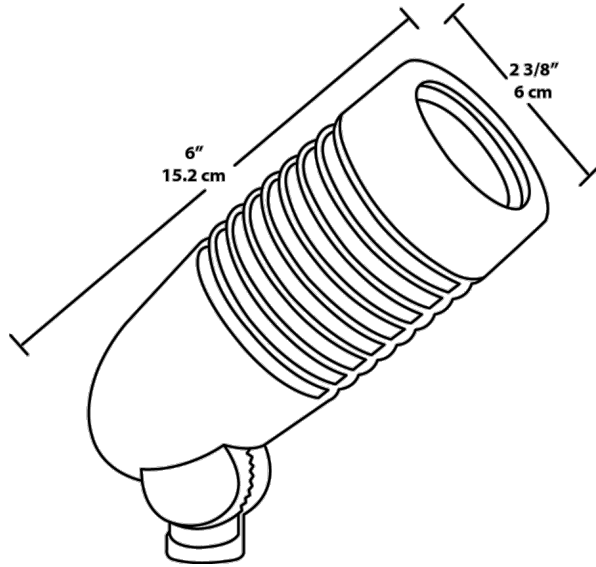

Features

- Microprismatic diffusion lens for even light distribution
- 4H x 4V NEMA type with 44° Beam Angle
- Optional spot hood reflector available
- 100,000 hour life based on LM-80 tests
- 5-year warranty

Ordering Matrix

Family	Watts	Color Temp	Finish
LFLED	5 = 5W	Blank = 5000K (Cool) Y = 3000K (Warm) N = 4000K (Neutral)	A = Bronze W = White B = Black VG = Verde Green