

# MDLED2X12F-40Y-W



<b>Project:</b>	<b>Type:</b>
<b>Prepared By:</b>	<b>Date:</b>

<b>Driver Info</b>		<b>LED Info</b>	
Type:	Constant Current	Watts:	24W
120V:	0.24A	Color Temp:	3000K
208V:	0.16A	Color Accuracy:	90 CRI
240V:	0.14A	L70 Lifespan:	N/A
277V:	0.12A	Lumens:	1,834
Input Watts:	31W	Efficacy:	60 LPW
Efficiency:	78%		

## Technical Specifications

### Listings

#### UL Listing:

Suitable for damp locations

#### IESNA LM-79 & LM-80 Testing:

RAB LED luminaires have been tested by an independent laboratory in accordance with IESNA LM-79 and LM-80, and have received the Department of Energy "Lighting Facts" label.

### Construction

#### IC Rating:

Suitable for direct contact with insulation

#### Gear Tray Component:

This component must be ordered with Remodeler or New Construction housing in order to make a complete fixture.

#### Cold Weather Starting:

The minimum starting temperature is -40°C/-40°F

#### Ambient Temperature:

Suitable for use in 55°C ambient temperatures.

#### Lens:

Nanostructure lens eliminates "hot spots", and provides smooth, uniform light at higher efficiency.

#### Reflector:

40°

#### Finish:

Our environmentally friendly polyester powder coatings are formulated for high-durability and long-lasting color, and contain no VOC or toxic heavy metals.

#### Green Technology:

Mercury and UV free. RoHS compliant components. Polyester powder coat finish formulated without the use of VOC or toxic heavy metals.

### Other

#### Brackets:

Butterfly brackets allow mounting with 1/4 x 1/2" bar stock, C Channel, 1/2" conduit, or nailer bars.

#### Thermal Protection:

Thermal protector included with On/OFF driver. Disables power if temperature exceeds safe operation levels.

#### Color Gels:

MDLED works great with third-party color gels to achieve a dramatic effect or a subtle accent. Plus, cool running LED won't degrade the gels like hot halogen lamps.

#### Tray and Heads:

Professional-grade, die-cast aluminum construction.

#### California Title 24:

See MDLED models with dimming driver for a 2013 California Title 24 compliant product. Any additional component requirements will be listed in the Title 24 section under technical specifications on the product page.

#### Warranty:

RAB warrants that our LED products will be free from defects in materials and workmanship for a period of five (5) years from the date of delivery to the end user, including coverage of light output, color stability, driver performance and fixture finish.

#### Country of Origin:

Designed by RAB in New Jersey and assembled in the USA by RAB's IBEW Local 3 workers.

#### Buy American Act Compliant:

This product is a COTS item manufactured in the United States, and is compliant with the Buy American Act.

#### Recovery Act (ARRA) Compliant:

This product complies with the 52.225-21 "Required Use of American Iron, Steel, and Manufactured Goods-- Buy American Act-- Construction Materials (October 2010).

#### Trade Agreements Act Compliant:

This product is a COTS item manufactured in the United States, and is compliant with the Trade Agreements Act.

#### GSA Schedule:

Suitable in accordance with FAR Subpart 25.4.

### Electrical

#### Driver:

On/Off Non-Dimming, Constant Current, Class 2, 100-277V, 50/60Hz, 4KV Surge Protection, 350mA, 100-240VAC 0.3-0.15A, 277VAC 0.15A, Power Factor 99%, THD ≤ 20%.

### LED Characteristics

#### LED:

High-output, long-life LED with 2 step binning and integrated driver technology.

#### Color Consistency:

2-step MacAdam Ellipse binning to achieve consistent fixture-to-fixture color.

#### Color Stability:

LED color temperature is warranted to shift no more than 200K in CCT over a 5 year period.

# MDLED2X12F-40Y-W

## Dimensions

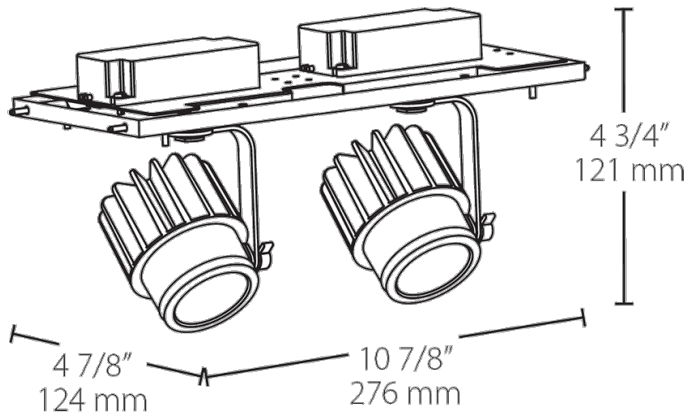

## Features

Two 12 Watt LED heads

Fixture heads rotate a full 360° and tilt up to 45°

Easily lock heads in place with a thumb screw

Tool-less adjustment for 3 discrete positions: full recess, flush mount or semi-recessed