

**Project:**

**Type:**

**Prepared By:**

**Date:**



UPC: 019813510446



### Features and Benefits

Produces rich and vibrant colors >90CRI

Energy efficient replacement for incandescent and halogen Small diameter reflectors

Constructed from durable materials which lowers risk of breakage

Rated for use in enclosed and open fixtures in dry or damp locations

Single optic and full face lens for precise beam angle control

Longer lifespan compared to legacy equivalents minimizes replacement and maintenance costs

Title 20 Compliant, ENERGY STAR Compliant, UL Listed

Compatible with low voltage transformers (check compatibility list)

## Technical Specifications

### Performance

**Product Type:**

Small-Reflector

**Input Wattage:**

5W

**Typical Lumen Output:**

400

**Efficacy:**

80 lm/W

**Color Temperature:**

4000K Cool White

**CRI:**

≥90

**L70 Lifespan:**

25,000 Hours

**Dimmable:**

Yes

### Construction

**Bulb Shape:**

MR16

**Base Type:**

GU5.3

**Beam Angle:**

25°

### Other

**Equivalency:**

35W Halogen

### Warranty (Years):

RAB warrants that our LED products will be free from defects in materials and workmanship for a period of five (5) years from the date of delivery to the end user, including coverage of light output, color stability, driver performance and fixture finish. RAB's warranty is subject to all terms and conditions found at [rablighting.com/warranty](http://rablighting.com/warranty).

### Electrical

**Power Factor:**

>0.9

**Operating Temperature:**

-20°C - 45°C

**Input Voltage:**

12V

## Technical Specifications (continued)

### Technical Specifications

#### For Use Outdoors in Open Fixtures:

No

### Electrical Characteristics

#### Flicker:

≤30%

### Compliance

#### UL Listed:

Yes

### ENERGY STAR V2.0:

This product is ENERGY STAR® Version 2.0 Certified

### Energy Star ID:

2351520

### Model Number:

R10017

### CEC Status:

Lawful for sale in California

## Case and Pallet Dimensions

	QTY	LENGTH (in)	WIDTH (in)	HEIGHT (in)
CASE	12	8.74	6.61	2.165
PALLET	5760	44.49	40.47	45.35

## Dimension

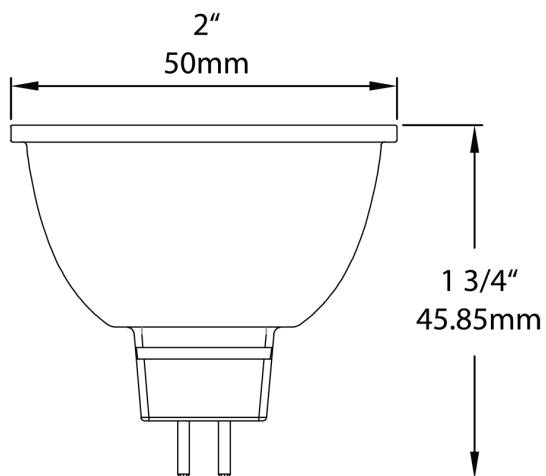

## Light Distribution

