

MR16-6-927-35D-DIM



Replace conventional MR16 halogen bulbs. Dimmable LED, 90 CRI.

Color: White

Weight: 0.1 lbs

Case Qty: 12

Project:	Type:
Prepared By:	Date:

Driver Info		LED Info	
Watts:	7W	Input Voltage:	12V
Color Temp:	2700K (Soft White)	Power Factor:	0.9
Lumens:	420	Flicker:	<30%
Efficacy:	65 LPW	THDi:	N/A
Color Accuracy:	90 CRI		
L70 Accuracy:	25,000		

Technical Specifications

Listings

UL Listed:

Yes

FCC:

Yes

T20:

Complies with CEC Title 20

T24:

Complies with Title 24 Appendix JA8

Rohs:

Yes

ENERGY STAR V2.0:

This product is ENERGY STAR® Version 2.0 Certified

CEC Status:

Lawful for sale in California

Description

Dimmable:

Yes

Lamp Type:

Mini-reflector

Bulb Type:

MR16

Base Type:

GU5.3

Material:

Aluminum

LED Characteristics

Lifespan:

25,000-hour LED lifespan based on IES LM-70 results

Other

Equivalent:

35W Halogen MR16

Warranty:

4 years

Optical

Beam Angle:

35°

Shipping Information

Case Dimensions:

7.68 x 5.71 x 2.56

Pallet Quantity of Pieces:

2064

Pallet Dimensions:

47.83 x 39.96 x 10.24

Construction

MOL:

1.87"

MOD:

1.97"

Dimensions

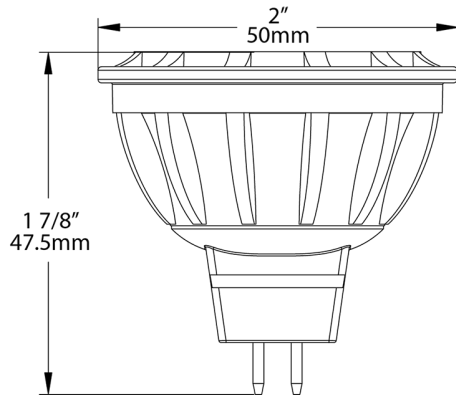

Features

Saves 80% energy compared to traditional Halogen small diameter reflectors

90 CRI: Produces rich and vibrant colors

25,000 and 40,000 hours - Long life and extra-long life

Suitable for damp locations

Suitable for use in enclosed fixtures