



Replace conventional MR16 halogen bulbs. Dimmable LED, 90 CRI.

Color: White

Weight: 0.1 lbs

Case Qty: 12

<b>Project:</b>	<b>Type:</b>
<b>Prepared By:</b>	<b>Date:</b>

Driver Info		LED Info	
Watts:	9W	Input Voltage:	12V
Color Temp:	3000K (Warm White)	Power Factor:	0.9
Lumens:	540	Flicker:	<30%
Efficacy:	64 LPW	THDi:	N/A
Color Accuracy:	90 CRI		
L70 Accuracy:	25,000		

## Technical Specifications

### Listings

**UL Listed:**

Yes

**FCC:**

Yes

**T24:**

Complies with Title 24 Appendix JA8

**Rohs:**

Yes

**ENERGY STAR V2.0:**

This product is ENERGY STAR® Version 2.0 Certified

### Description

**Dimmable:**

Yes

**Lamp Type:**

Mini-reflector

**Bulb Type:**

MR16

**Base Type:**

GU5.3

**Material:**

Aluminum

### LED Characteristics

**Lifespan:**

25,000-hour LED lifespan based on IES LM-70 results

**Other**

**Equivalent:**

50W Halogen MR16

**Warranty:**

4 years

### Optical

**Beam Angle:**

15°

### Shipping Information

**Case Dimensions:**

7.68 x 5.71 x 2.56

**Pallet Quantity of Pieces:**

2064

**Pallet Dimensions:**

47.83 x 39.96 x 10.24

### Construction

**MOL:**

1.87"

**MOD:**

1.97"

## Dimensions

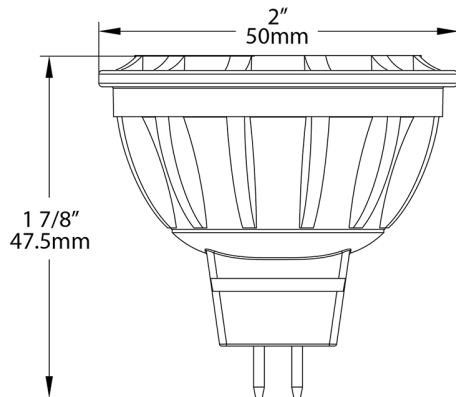

## Features

Saves 80% energy compared to traditional Halogen small diameter reflectors

90 CRI: Produces rich and vibrant colors

25,000 and 40,000 hours - Long life and extra-long life

Suitable for damp locations

Suitable for use in enclosed fixtures