

Easy to install 6" rough-in with die-cast aperture ring, removable driver, thermal protector and adjustable butterfly brackets. This rough-in is designed to make new construction recessed downlighting easy Available with 80 or

Color: See Trim Module\*

Weight: 2.0 lbs

**Project:**

**Type:**

**Prepared By:**

**Date:**

#### Driver Info

Type: Constant Current  
 120V: 0.24A  
 208V: 0.14A  
 240V: 0.13A  
 277V: 0.12A  
 Input Watts: See Trim Module\*  
 Efficiency: N/A

#### LED Info

Watts: 26W  
 Color Temp: See Trim Module\*  
 Color Accuracy: 80 CRI  
 L70 Lifespan: N/A  
 Lumens: See Trim Module\*  
 Efficacy: N/A

## Technical Specifications

### Lightcloud

#### Lightcloud Installed:

Lightcloud is a commercial wireless lighting control system and service fully developed and supported by RAB. It's powerful and flexible, yet easy to use and install.

### Listings

#### UL Listed:

Suitable for wet locations covered ceiling.

#### ENERGY STAR:

This product is ENERGY STAR® qualified.

### Construction

#### IC Rating:

Suitable for direct contact with insulation

#### Housing Component:

This component must be ordered with New Construction Square Trim Module in order to make a complete fixture.

#### Ambient Temperature:

Suitable for use in 40°C ambient temperatures.

#### Cold Weather Starting:

The minimum starting temperature is -40°C/-40°F

#### Aperture Size:

6" Rough-In.

#### Drop Ceiling Installation:

NDLED can be installed in drop ceiling tiles when using optional c-channel bars and following local construction codes.

#### Junction Box:

Integral junction box with wiring capacity for Min 90°C supply conductors  
 4 in 4 out

#### Mounting:

Housing includes nailer bars and butterfly brackets. Brackets also accommodate mounting with 1/4" to 1/2" bar stock, C channel or 1/2" conduit.

#### Easy Installation:

The EZConnector makes installation easy.

#### Thermal Protector:

Thermal protector included. Disables power if temperature exceeds safe operation levels.

### Optical

#### Photometrics:

Photometrics are based on prorated reports. Contact the RAB Lighting Design department for the most up-to-date data.

### Electrical

#### Driver:

ELV, 0-10V and TRIAC Dimming, Constant Current, Class 2, 120V-277V, 50/60Hz, Power Factor 98%, THD ≤ 20%.

#### Dimming Driver:

0 - 10V (at 120-277V), TRIAC and ELV (at 120V only).

### Other

#### Insulation Contact (IC):

Allows direct contact with insulation or keep insulation 3" from fixture at all times.

#### Equivalency:

Equivalent to 100W PAR.

#### Air Tight:

Housing certified Air Tight as per ASTM E283

#### California Title 24:

ND6S26F complies with 2013 California Title 24 building and electrical codes as a residential indoor fixture. See NDLED models with dimming drivers for products that comply as commercial indoor fixtures for general spaces. Any additional component requirements will be listed in the Title 24 section under technical specifications on the product page.

#### Warranty:

RAB warrants that our LED products will be free from defects in materials and workmanship for a period of five (5) years from the date of delivery to the end user, including coverage of light output, color stability, driver performance and fixture finish.

## Dimensions

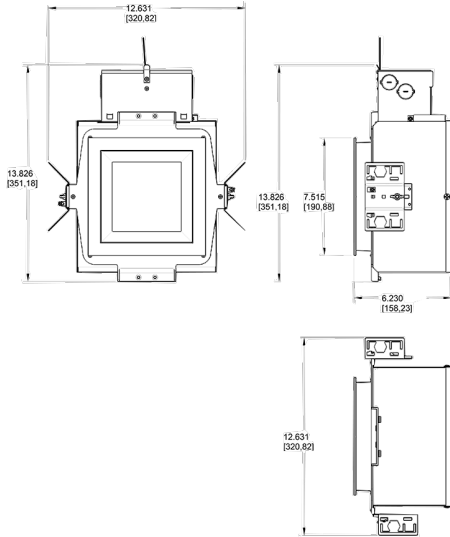

## Features

- Butterfly bracket allows mounting with bar stock, "C" channel, 1/2" conduit or nailer bars
- Low-profile design allows for installation in ceilings with limited space
- Sturdy design with die cast aperture frame

## Ordering Matrix

Family	Type	Size	Shape	Driver	Watts	Battery Backup
ND	Blank = Standard IC = Insulation Contact (IC)	6 = 6"	S = Square	D = Universal Dimming	20 = 20W 26 = 26W	Blank = No Battery Backup /E2 = 120-277V Backup