



Die-cast aluminum trim cone with high-efficiency TIR optics.

Color: Black

Weight: 0.7 lbs

Project:	Type:
Prepared By:	Date:

Driver Info		LED Info	
Type:	Sold Separately	Watts:	0W
120V:	See Rough-in*	Color Temp:	N/A
208V:	See Rough-in*	Color Accuracy:	N/A
240V:	See Rough-in*	L70 Lifespan:	See Rough-In*
277V:	See Rough-in*	Lumens:	N/A
Input Watts:	0W	Efficacy:	N/A
Efficiency:	N/A		

Technical Specifications

Listings

UL Listing:

Suitable for wet locations in a covered ceiling

Optical

Photometrics:

Photometrics are based on prorated reports. Contact the RAB Lighting Design department for the most up-to-date data.

Optics:

High-efficiency TIR optics available as a trimless 50° beam downlight. Optic and trim cone included.

Construction

Trim Component:

This component must be ordered with New Construction Rough-In in order to make a complete fixture.

Trim Cone:

Black square trim cone, die-cast aluminum.

Trim:

Trimless

Lens:

Low-glare Solite glass eliminates "hot spots", and helps provide smooth, uniform light

Installation:

Nailer bar and butterfly brackets included; C-channels optional for acoustic tiles

Green Technology:

Mercury and UV free. RoHS compliant components.

Other

Aperture Size:

3" Trim Module

Warranty:

RAB warrants that our LED products will be free from defects in materials and workmanship for a period of five (5) years from the date of delivery to the end user, including coverage of light output, color stability, driver performance and fixture finish.

Country of Origin:

Designed by RAB in New Jersey and assembled in the USA by RAB's IBEW Local 3 workers.

Buy American Act Compliant:

This product is a COTS item manufactured in the United States, and is compliant with the Buy American Act.

Recovery Act (ARRA) Compliant:

This product complies with the 52.225-21 "Required Use of American Iron, Steel, and Manufactured Goods-- Buy American Act-- Construction Materials (October 2010).

GSA Schedule:

Suitable in accordance with FAR Subpart 25.4.

NDTRIM3S50-B-TL

Dimensions

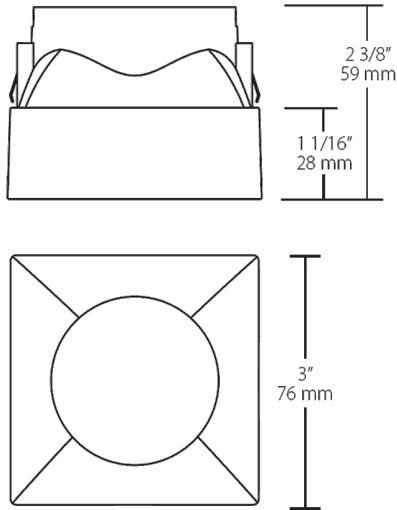

Features

- Durable die-cast aluminum
- High-efficiency TIR optics
- Optic and trim included

Ordering Matrix

Family	Size	Shape	Optics	Color	Trim
NDTRIM	3	S	50	B	TL
	3 = 3"	S = Square	80 = 80° Downlight 50 = 50° Downlight 40A = 40° Adjustable 20A = 20° Adjustable W = Wall Washer	B = Black W = White M = Matte Silver	Blank = Trimmed TL = Trimless