



LED High Bay fixture ideal for large indoor spaces, including warehouses, gymnasiums and distribution centers that require mounting heights from 15 to 50 feet.

Color: White

Weight: 13.4 lbs

<b>Project:</b>	<b>Type:</b>
<b>Prepared By:</b>	<b>Date:</b>

Driver Info		LED Info	
Type:	Constant Current	Watts:	95W
120V:	0.78A	Color Temp:	4000K
208V:	0.47A	Color Accuracy:	77 CRI
240V:	0.41A	L70 Lifespan:	100000
277V:	0.35A	Lumens:	12176
Input Watts:	91W	Efficacy:	134 LPW
Efficiency:	N/A		

## Technical Specifications

### Listings

#### UL Listing:

Suitable for damp locations

#### DLC Listed:

This product is listed by Design Lights Consortium (DLC) as an ultra-efficient premium product that qualifies for the highest tier of rebates from DLC Member Utilities.

DLC Product Code: PRSR2249

#### IESNA LM-79 & LM-80 Testing:

RAB LED luminaires have been tested by an independent laboratory in accordance with IESNA LM-79 and LM-80, and have received the Department of Energy "Lighting Facts" label.

### LED Characteristics

#### Lifespan:

100,000-hour LED lifespan based on IES LM-80 results and TM-21 calculations.

#### LEDs:

Long-life, high-efficiency surface mounting LEDs

#### Color Stability:

LED Color temperature is warrantied to shift no more than 200K in CCT over a 5 year period.

#### Color Uniformity:

RAB's range of CCT (Correlated Color Temperature) follows the guidelines of the American National Standard for Specifications for the Chromaticity of Solid State Lighting (SSL) Products, ANSI C78.377-2015.

### Electrical

#### Driver:

One Driver, Class 2, Constant Current, 100-277VAC, 50-60Hz, 4kV, 1.1A,

#### Dimming Driver:

Driver includes dimming control wiring for 0-10V dimming systems. Requires separate 0-10V DC dimming circuit. Dims as low as 10%.

#### THD:

5.6% at 120V, 9.7% at 277V

#### Power Factor:

99.8% at 120V, 93% at 277V

### Construction

#### Lens:

High-transmittance polystyrene

#### Reflector:

Specular, high-reflectance aluminum with 95% reflectivity

#### Mounting:

3/4" NPS for pendant mount (pendant by others) or direct surface knockout on junction box for mounting to ceiling. Mounting hardware (not provided) should be suitable to mounting surface.

#### Gaskets:

High temperature silicone gaskets.

#### Finish:

Formulated for high-durability and long lasting color.

#### Green Technology:

Mercury and UV free. RoHS compliant components. Polyester powder coat finish formulated without the use of VOC or toxic heavy metals.

#### Recommended Mounting Height:

Up to 25 ft.

### Other

#### Equivalency:

Equivalent to 250W HID fixtures at 25' mounting height. Replacement is 400W HID fixtures replacement at 35' mounting height, low activity warehouse.

#### Warranty:

RAB warrants that our LED products will be free from defects in materials and workmanship for a period of five (5) years from the date of delivery to the end user, including coverage of light output, color stability, driver performance and fixture finish.

#### California Title 24:

See RAIL with Multi-Level sensor (/WS2 or /WS4) for a compliant California Title 24.

#### Bi-Level:

Allows 25%, 50% or 75% output modes.

#### Country of Origin:

Designed by RAB in New Jersey and assembled in the USA by RAB's IBEW Local 3 workers.

#### Buy American Act Compliant:

This product is a COTS item manufactured in the United States, and is compliant with the Buy American Act.

#### Recovery Act (ARRA) Compliant:

This product complies with the 52.225-21 "Required Use of American Iron, Steel, and Manufactured Goods-- Buy American Act-- Construction Materials (October 2010).

#### Trade Agreements Act Compliant:

This product is a COTS item manufactured in the United States, and is compliant with the Trade Agreements Act.

## Technical Specifications (continued)

### Other

#### GSA Schedule:

Suitable in accordance with FAR Subpart 25.4.

### Sensor Specifications

#### Handheld Wireless Configuration Tool:

Adjust settings using handheld wireless configuration tool. Only available with 0-10V dimming driver options.

## Dimensions

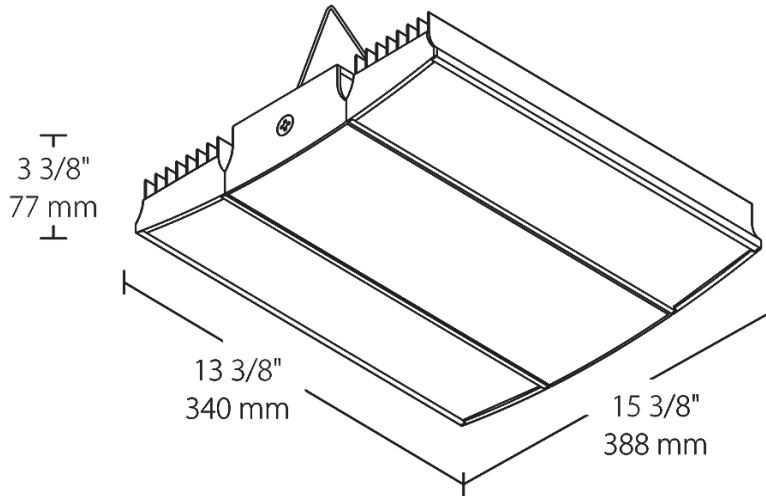

## Features

- Ideal for large spaces
- Ultra-high efficacy
- Up to 60% less energy usage than equivalent metal halide fixtures
- 100,000 hour lifespan, virtually maintenance free operation
- Optional 0-10V driver for variable dimming down to 10%