



Project:	Type:
Prepared By:	Date:

Driver Info		LED Info	
Type	Constant Current	Watts	6W
120V	0.06A	Color Temp	3000K
208V	N/A	Color Accuracy	80 CRI
240V	N/A	L70 Lifespan	11,000 Hours
277V	N/A	Lumens	550
Input Watts	6W	Efficacy	92

Technical Specifications

Performance

Description:

These ultra-economy downlights are ideal for both new construction and retrofit applications. Our low profile design makes them compatible with most recessed housing to be easily mounted using the integrated friction clips/torsion springs or the E26 Edison base adapter.

Product Type:

Recessed Downlights

Input Wattage:

6W

Lumens (Nominal):

550lm

Efficacy:

92 lm/W

Lifespan:

11,000-Hour LED lifespan based on IES LM-80 results and TM-21 calculations

Compliance

UL Listed:

Suitable for wet locations

Electrical

Dimming Driver:

TRIAC compatible dimmer with dimming as low as 10%.

THD:

≤20%

Power Factor:

≥0.9

Flicker:

≤30%

Input Voltage:

120V

Operating Frequency:

60Hz

Construction

Material:

Plastic

Technical Specifications (continued)

Construction

Trim Style:

Smooth Trim

Base Type:

E26

Shape:

Round

Mounting:

Recessed ceiling

Operating Temperature:

-20°C (-4°F) to 40°C (104°F)

Size:

4"

Other

Warranty:

RAB warrants that our LED products will be free from defects in materials and workmanship for a period of three (3) years from the date of delivery to the end user, including coverage of light output, color stability, driver performance and fixture finish. RAB's warranty is subject to all terms and conditions found at rablighting.com/warranty.

Buy American Act Compliance:

RAB values USA manufacturing! Upon request, RAB may be able to manufacture this product to be compliant with the Buy American Act (BAA). Please contact customer service to request a quote for the product to be made BAA compliant.

Dimensions

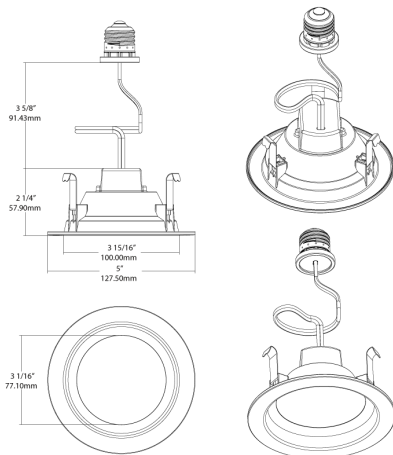

Features

Suitable for outdoor use in dry, damp, and wet environments

Dimmable down to 10% on triac dimmers

Anti-UV plastic extends the life of the housing

UL Listed, UL Recognized

Ordering Matrix

Family	Size	Shape	Wattage	CRI/Color Temp	Voltage	Finish	Trim
RET34	4	R	6	830	120	W	S
	4 = 4" 6 = 6"	R = Round	6 = 6W 7 = 7W	840 = 80 CRI, 4000K 830 = 80 CRI, 3000K	120 = 120V	W = White	S = Smooth