

Project:	Type:
Prepared By:	Date:

Driver Info		LED Info	
Type	Constant Current	Watts	14W
120V	0.13A	Color Temp	2700K/3000K/3500K/4000K/5000K
208V	N/A	Color Accuracy	90 CRI
240V	N/A	L70 Lifespan	50,000 Hours
277V	N/A	Lumens	1,200
Input Watts	8W	Efficacy	85.7

Technical Specifications

Performance

Description:

The SUMO offers a sleek, low-profile design that adds a modern look to any space. They are easy to install with field adjustable color temperature, affordable, and a stylish options for new construction or retrofit. Mounting kit for recessed housing sold separately.

Product Type:

Surface & Flush Mounts

Input Wattage:

14W

Lumens (Nominal):

1200lm

Efficacy:

85.7 lm/W

L70 Lifespan:

50,000-Hour LED lifespan based on IES LM-70 results

R9 Value:

High color performance with R9 greater than or equal to 50

Compliance

UL Listed:

Suitable for wet locations

ENERGY STAR V2.2:

This product is ENERGY STAR® Version 2.2 Certified.

Energy Star ID:

2389838

Electrical

Dimming Driver:

TRIAC compatible dimmer with dimming as low as 10%.

THD:

≤20%

Power Factor:

≥0.9

Flicker:

≤30%

Technical Specifications (continued)

Electrical

Input Voltage:

120V

Operating Frequency:

60Hz

Construction

Material:

Plastic

Trim Style:

Smooth Trim

Shape:

Round

Mounting:

Surface and recessed mount

Operating Temperature:

-20°C (-4°F) to 40°C (104°F)

Size:

7"

Optical

Beam Angle:

110°

Other

Warranty:

RAB warrants that our LED products will be free from defects in materials and workmanship for a period of five (5) years from the date of delivery to the end user, including coverage of light output, color stability, driver performance and fixture finish. RAB's warranty is subject to all terms and conditions found at rablighting.com/warranty.

Trade Agreements Act Compliant:

This product is a product of Cambodia and a "designated country" end product that complies with the Trade Agreements Act

Buy American Act Compliance:

RAB values USA manufacturing! Upon request, RAB may be able to manufacture this product to be compliant with the Buy American Act (BAA). Please contact customer service to request a quote for the product to be made BAA compliant.

Dimensions

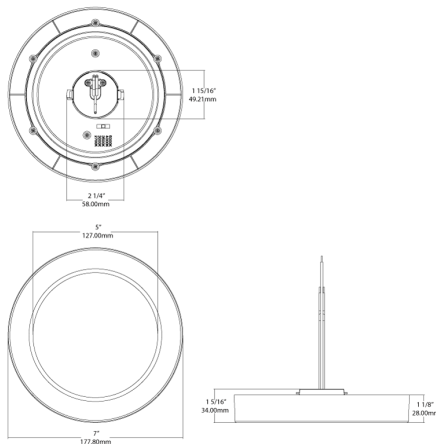

Features

- Surface or Recessed mounting options
- Select from 5 field-adjustable color temperatures 2700K, 3000K, 3500K, 4000K, or 5000K
- Suitable for wet and damp locations
- Compatible with triac dimming systems, see Dimmer Compatibility List
- Meets California Title 24 requirements
- Mounting kit for recessed housing sold separately

Ordering Matrix

Family	Size	Shape	Wattage	Color Temp	Voltage	Finish
SUMOFA	7	R	14	9CCT	120	W
	5 = 5.5" 7 = 7" 9 = 9"	R = Round S = Square	10 = 10W 12 = 12W 13 = 13W 14 = 14W 16 = 16W 18 = 18W 22 = 22W	9CCT = 5000/4000/3500/3000/2700K 95CCT = 5000/4000/3500/3000/2700K	120 = 120V, Triac Dimming UNV = 120/277V, 0-10V Dimming UNVT = 120/277V, Triac Dimming	W = White