



Sensor controlled Vandalproof fixtures. VAN 3 up to 42 Watts CFL. VAN5 up to 96 Watts CFL, VAN6 up to 26 Watts CFL @ 120v. Sensor color matched to fixture. Sensor is not vandalproof. Lamp supplied.

Color: Bronze

Weight: 7.0 lbs

Project:	Type:
Prepared By:	Date:

Lamp Info		Ballast Info	
Type:	42W Triple	Type:	Electronic QT
Watts:	42W	120V:	0.38A
Shape/Size:	N/A	208V:	N/A
Base:	N/A	240V:	N/A
ANSI:	N/A	277V:	N/A
Hours:	12,000	Input Watts:	46W
Lamp Lumens:	3,200	Efficiency:	91%
Efficacy:	70 LPW		

Technical Specifications

Listings

UL Listing:

Suitable for wet locations.

Electrical

Voltage:

120 volts AC 60 Hz.

Surge Protection:

Withstands up to 3000 volts.

Manual Override:

Double flip wall switch logic prevents activation by short power outages. Resets after 8 hours. No extra wiring needed.

Sensor Characteristics

Time Adjustment:

5 seconds to 15 minutes CFL lamps have longer life if Time Adjustment is set to > 7 minutes.

Quick Test Time:

5 seconds test time for fast installation. Works day or night.

Other

"No Hands" Auto Testing:

Auto mode starts after 4 minutes of testing. No adjustment needed.

Sensor Case Construction:

Precision molded Lexan.

Photocontrol:

Deactivates lights during daylight. Fully adjustable for 24 hour operation or custom applications. Please specify voltage.

Min Start Temp:

0°.

Country of Origin:

Designed by RAB in New Jersey and assembled in the USA by RAB's IBEW Local 3 workers.

Buy American Act Compliant:

This product is a COTS item manufactured in the United States, and is compliant with the Buy American Act.

Recovery Act (ARRA) Compliant:

This product complies with the 52.225-21 "Required Use of American Iron, Steel, and Manufactured Goods-- Buy American Act-- Construction Materials (October 2010).

Trade Agreements Act Compliant:

This product is a COTS item manufactured in the United States, and is compliant with the Trade Agreements Act.

GSA Schedule:

Suitable in accordance with FAR Subpart 25.4.

Construction

Vandal Resistant Lens:

Hard lens resists vandalism.

Built for Severe Conditions:

Double weatherproofing for long life.

Ballast Minimum Starting Temperature:

0°F.

LED Characteristics

LED Detection Indicator:

Glows red day and night for "on-guard" deterrence.

Dimensions

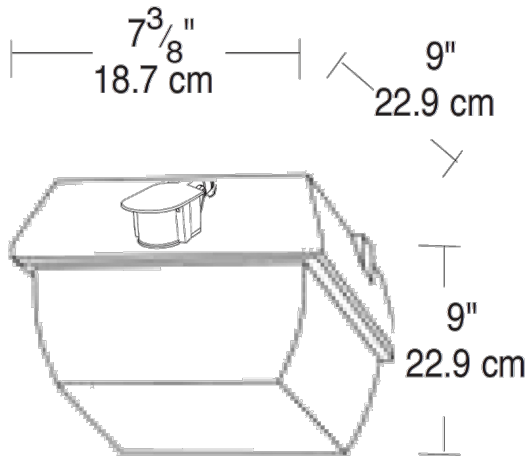

Features

- Precision die cast aluminum housing with durable polyester powder coating
- Cutoff and standard Wallpacks
- LED "on guard" indicator
- Can be wired in parallel
- Adjustable mini sensor with 180 detection patterned
- Sensor color matches fixture
- Vandal proof fixtures offer sensor controlled compact fluorescent up to 96 Watts