



Die cast aluminum construction. Wall bracket plus junction box with sturdy mounting lugs. Medium base socket, 1/2" or 3/4" NPS hub size and a variety of globes. incandescent lamp A21 for 100 series, PS25 for 200 Series. Lamp not supplied.

Color: White

Weight: 3.7 lbs

Project:	Type:
Prepared By:	Date:

Lamp Info		Ballast Info	
Type:	A19	Type:	N/A
Watts:	150W	120V:	N/A
Shape/Size:	N/A	208V:	N/A
Base:	N/A	240V:	N/A
ANSI:	N/A	277V:	N/A
Hours:	N/A	Input Watts:	0W
Lamp Lumens:	N/A		
Efficacy:	N/A		

Technical Specifications

Listings

UL Listing:

Suitable for wet locations. Suitable for use in dwellings. Suitable for use with 90°C supply wiring. Complies with UL Standard 1598. For non-hazardous locations where the lamp, socket and wiring require protection from rain, corrosive fumes, non-combustible dusts, moisture, non-explosive vapors and gases.

Electrical

Wattage:

See catalog number chart for maximum wattage with clear glass, colored glass and Permaglobes.

Socket:

Premium porcelain with 150°C 8" leads attached. Fastened with 2 stainless steel screws.

Maximum Watts:

150 watts

Colored Globe Maximum Watts:

100 watts

Construction

Globes:

Supplied with clear heat resistant glass globes unless otherwise stated. Colored and white glass globes available. Unbreakable RAB Permaglobes available in clear and in color.

Optional Reflectors:

Highly reflective white baked polyester epoxy powder finish over a heavy gauge aluminum base. Reflectors thread onto fixtures. See RV series.

Die Cast Guard:

Supplied with one piece white die cast guard with set screw.

Other

Country of Origin:

Designed by RAB in New Jersey and assembled in the USA by RAB's IBEW Local 3 workers.

Buy American Act Compliant:

This product is a COTS item manufactured in the United States, and is compliant with the Buy American Act.

Recovery Act (ARRA) Compliant:

This product complies with the 52.225-21 "Required Use of American Iron, Steel, and Manufactured Goods-- Buy American Act-- Construction Materials (October 2010).

Trade Agreements Act Compliant:

This product is a COTS item manufactured in the United States, and is compliant with the Trade Agreements Act.

GSA Schedule:

Suitable in accordance with FAR Subpart 25.4.

Dimensions

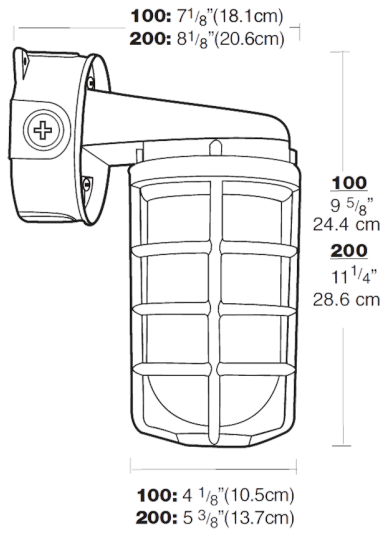

Features

- Set screw keeps guard securely in place
- Junction box with sturdy mounting lugs
- All stainless steel hardware
- Close-up plugs allow Phillips or slotted screwdrivers for easy installation
- High temperature silicone internal gaskets
- Premium porcelain socket with 150C 8" long leads attached
- Clear heat resistant glass globes standard Polycarbonate Permaglobes available