



LED 104W Wallpacks. 3 cutoff options. Patent Pending thermal management system. 100,000 hour L70 lifespan. 5 Year Warranty.

Color: Bronze

Weight: 26.0 lbs

Project:	Type:
Prepared By:	Date:

Driver Info		LED Info	
Type:	Constant Current	Watts:	104W
120V:	0.95A	Color Temp:	3000K
208V:	0.59A	Color Accuracy:	82 CRI
240V:	0.51A	L70 Lifespan:	100000
277V:	0.44A	Lumens:	8,701
Input Watts:	106W	Efficacy:	82 LPW
Efficiency:	98%		

Technical Specifications

Other

WPLED104 with Bi-Level Operation:

Allows 50% and 100% output modes.

Equivalency:

The WPLED104 is Equivalent in delivered lumens to a 400W Metal Halide Wallpack.

California Title 24:

WPLED104/BL with bi-level operation complies with 2013 California Title 24 building and electrical codes as a commercial outdoor pole-mounted fixture > 30 Watts mounted up to 24 feet when used with a RAB photo/motion control. Select a photo/motion control using catalog number STL110, STL200 or STL360. Mounting heights greater than 24 feet require only a photocell. See WPLED104/PCS or WPLED104/PCS2 (277V) for photocell versions.

Patents:

The design of the WPLED104 is protected by patents pending in US, Canada, China, Taiwan and Mexico.

Country of Origin:

Designed by RAB in New Jersey and assembled in the USA by RAB's IBEW Local 3 workers.

Buy American Act Compliant:

This product is a COTS item manufactured in the United States, and is compliant with the Buy American Act.

Recovery Act (ARRA) Compliant:

This product complies with the 52.225-21 "Required Use of American Iron, Steel, and Manufactured Goods-- Buy American Act-- Construction Materials (October 2010).

Trade Agreements Act Compliant:

This product is a COTS item manufactured in the United States, and is compliant with the Trade Agreements Act.

GSA Schedule:

Suitable in accordance with FAR Subpart 25.4.

Warranty:

RAB warrants that our LED products will be free from defects in materials and workmanship for a period of five (5) years from the date of delivery to the end user, including coverage of light output, color stability, driver performance and fixture finish.

Listings

UL Listing:

UL Suitable for Wet Locations as Uplight and Downlight Wall Mount Only.

IESNA LM-79 & LM-80 Testing:

RAB LED Luminaires have been tested by an independent laboratory in accordance with IESNA LM-79 and LM-80, and have received the Department of Energy "Lighting Facts" label.

Construction

IP Rating:

Ingress Protection rating of IP66 for dust and water.

Cold Weather Starting:

Minimum starting temperature is -40°F / -40°C

Maximum Ambient Temperature:

Suitable for use in 40°C (104°F) ambient temperatures

Thermal Management:

Superior thermal management with external Air-Flow fins.

Housing:

Precision die-cast aluminum housing, door frame arm and wall bracket.

Mounting:

Die-cast aluminum wall bracket with (5) 1/2" conduit openings with plugs. Two-piece bracket with tether for ease of installation and wiring.

Arm:

Die-cast aluminum with wiring access plate.

Cutoff:

Standard (15°)

Lens:

Tempered glass.

Reflector:

Specular vacuum metallized polycarbonate.

Gaskets:

High-temperature silicone

Finish:

Our environmentally friendly polyester powder coatings are formulated for high-durability and long-lasting color, and contains no VOC or toxic heavy metals.

Green Technology:

Mercury and UV free. RoHS compliant components. Polyester powder coat finish formulated without the use of VOC or toxic heavy metals.

LED Characteristics

LEDs:

Four multi-chip, high-output, long-life LEDs.

Technical Specifications (continued)

LED Characteristics

Lifespan:

100,000-hour LED lifespan based on IES LM-80 results and TM-21 calculations.

Color Consistency:

3-step MacAdam Ellipse binning to achieve consistent fixture-to-fixture color.

Color Stability:

LED color temperature is warranted to shift no more than 200K in CCT over a 5 year period.

Color Uniformity:

RAB's range of CCT (Correlated Color Temperature) follows the guidelines of the American National Standard for Specifications for the Chromaticity of Solid State Lighting (SSL) Products, ANSI C78.377.2011.

Electrical

Driver:

Two drivers, Constant current, Class 2, 100-277V, 50/60 Hz, 6kV Surge Protection, 700mA, 100-277V.

Dimensions

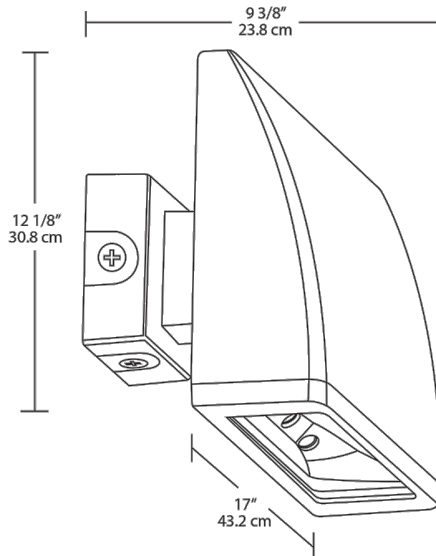

Features

- High performance LED light engine
- Maintains 70% of initial lumens at 100,000 hours
- Weatherproof high temperature silicone gaskets
- Superior heat sinking with die cast aluminum housing and external fins
- Replaces 400W MH
- 100 up to 277 Volts
- 5-year warranty

Ordering Matrix

Family	Cutoff	Watts	Color Temp	Finish	Voltage	Photocell	Bi-Level
WPLED							
	Blank = Standard C = Cutoff FC = Full Cutoff	104 = 104W	Blank = 5000K (Cool) Y = 3000K (Warm) N = 4000K (Neutral)	Blank = Bronze W = White	Blank = 120-277V /480 = 480V	Blank = No Photocell /PCS = 120V Swivel /PCS2 = 277V Swivel	Blank = No Bi-Level /BL = Bi-Level