



LED 52W Wallpacks. 3 cutoff options. Patent Pending thermal management system. 100,000 hour L70 lifespan. 5 Year Warranty.

Color: White

Weight: 17.6 lbs

Project:	Type:
Prepared By:	Date:

Driver Info		LED Info	
Type:	Constant Current	Watts:	52W
120V:	N/A	Color Temp:	4000K
208V:	N/A	Color Accuracy:	82 CRI
240V:	N/A	L70 Lifespan:	100000
277V:	N/A	Lumens:	4,589
Input Watts:	60W	Efficacy:	76 LPW
Efficiency:	87%		

Technical Specifications

Listings

UL Listing:

Suitable for wet locations.

IESNA LM-79 & LM-52 Testing:

RAB LED Luminaires have been tested by an independent laboratory in accordance with IESNA LM-79 and LM-52, and have received the Department of Energy "Lighting Facts" label.

LED Characteristics

LEDs:

Two (2) multi-chip, high-output, long-life LEDs.

Lifespan:

100,000-hour LED lifespan based on IES LM-52 results and TM-21 calculations.

Color Consistency:

3-step MacAdam Ellipse binning to achieve consistent fixture-to-fixture color.

Color Stability:

LED color temperature is warranted to shift no more than 200K in CCT over a 5 year period.

Color Uniformity:

RAB's range of CCT (Correlated Color Temperature) follows the guidelines of the American National Standard for Specifications for the Chromaticity of Solid State Lighting (SSL) Products, ANSI C78.377.2011.

Electrical

Driver:

Constant Current, Class 2, 1400mA, 277V-480V, 50-60Hz, 0.34A, Power Factor 99%

Surge Protection:

6kV

Construction

Cold Weather Starting:

Minimum starting temperature is -40°F / -40°C

Maximum Ambient Temperature:

Suitable for use in 40°C (104°F) ambient temperatures

Thermal Management:

Superior thermal management with external Air-Flow fins.

Housing:

Precision die cast aluminum housing, lens frame.

Mounting:

Die-cast aluminum wall bracket with (5) 1/2" conduit openings with plugs. Two-piece bracket with tether for ease of installation and wiring.

Arm:

Die-cast aluminum with wiring access plate.

Cutoff:

Cutoff (7.5°)

Lens:

Tempered glass.

Reflector:

Specular vacuum metallized polycarbonate.

Gaskets:

High-temperature silicone gaskets, including a wiring plug gasket, seal out moisture.

Finish:

Our environmentally friendly polyester powder coatings are formulated for high-durability and long-lasting color, and contains no VOC or toxic heavy metals.

Green Technology:

Mercury and UV free. RoHS compliant components. Polyester powder coat finish formulated without the use of VOC or toxic heavy metals.

Other

California Title 24:

See WPLEDC52/BL for a 2013 California Title 24 compliant product. Any additional component requirements will be listed in the Title 24 section under technical specifications on the product page.

Patents:

The WPLED design is protected by patents in the U.S. Pat D653,377, Canada Pat. 142252, China Pat. ZL201130356930.8, and Mexico Pat. 36921 and pending patent in TW.

Country of Origin:

Designed by RAB in New Jersey and assembled in the USA by RAB's IBEW Local 3 workers.

Buy American Act Compliant:

This product is a COTS item manufactured in the United States, and is compliant with the Buy American Act.

Recovery Act (ARRA) Compliant:

This product complies with the 52.225-21 "Required Use of American Iron, Steel, and Manufactured Goods-- Buy American Act-- Construction Materials (October 2010).

Technical Specifications (continued)

Other

Trade Agreements Act Compliant:

This product is a COTS item manufactured in the United States, and is compliant with the Trade Agreements Act.

GSA Schedule:

Suitable in accordance with FAR Subpart 25.4.

Warranty:

RAB warrants that our LED products will be free from defects in materials and workmanship for a period of five (5) years from the date of delivery to the end user, including coverage of light output, color stability, driver performance and fixture finish.

Optical

BUG Rating:

B1 U1 G1

Dimensions

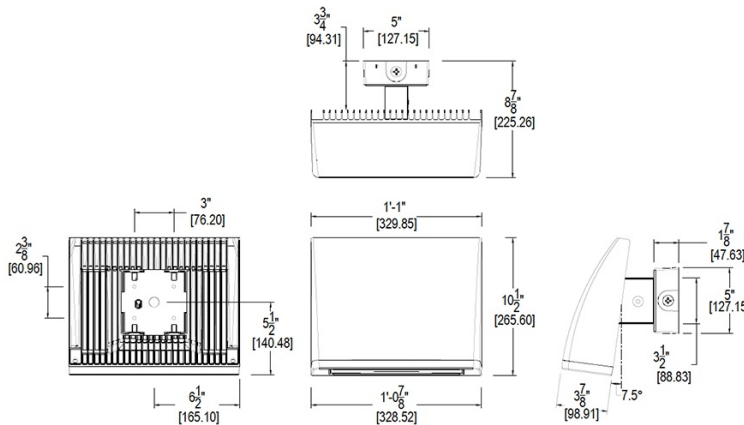

Features

- High performance LED light engine
- Maintains 70% of initial lumens at 100,000 hours
- Weatherproof high temperature silicone gaskets
- Superior heat sinking with die cast aluminum housing and external fins
- Replaces 250W MH
- Traditional wallpack look from the front
- 3 cutoff options
- 5-year warranty

Ordering Matrix

Family	Cutoff	Watts	Color Temp	Finish	Voltage	Photocell	Bi-Level	Dimming
WPLED								
	Blank = Standard (15°) C = Cutoff (7.5°) FC = Full Cutoff (0°)	52 = 52W	Blank = 5000K (Cool) Y = 3000K (Warm) N = 4000K (Neutral)	Blank = Bronze W = White	Blank = 120-277V /480 = 480V	Blank = Photocell /PCS = 120V Swivel /PCS2 = 277V Swivel /PCS4 = 480V Swivel	Blank = No Bi-Level /BL = Bi-Level (Only 120-277V)	Blank = No Dimming /D10 = Dimmable (Only 120-277V)