



High performance LED tallpack. Covers footprint of most HID Tallpacks. Vandal resistant lens. Precision die-cast aluminum. 0-10V dimmable driver with 120-277V photocell.

Color: White

Weight: 6.5 lbs

Project:	Type:
Prepared By:	Date:

Driver Info		LED Info	
Type:	Constant Current	Watts:	25W
120V:	0.201A	Color Temp:	4000K
208V:	0.126A	Color Accuracy:	73 CRI
240V:	0.109A	L70 Lifespan:	100000
277V:	0.096A	Lumens:	2517
Input Watts:	24W	Efficacy:	106 LPW
Efficiency:	N/A		

Technical Specifications

Listings

UL Listing:

Suitable for wet locations. Wall mount only.

IESNA LM-79 & LM-80 Testing:

RAB LED luminaires have been tested by an independent laboratory in accordance with IESNA LM-79 and LM-80, and have been received the Department of Energy "Lighting Facts" label.

LED Characteristics

Lifespan:

100,000-hour LED lifespan based on IES LM-80 results and TM-21 calculations.

LEDs:

Long-life, high-efficiency surface mounting LEDs

Color Stability:

LED color temperature is warranted to shift no more than 200K in CCT over a 5 year period.

Color Uniformity:

RAB's range of CCT (Correlated Color Temperature) follows the guidelines of the American National Standard for Specifications for the Chromaticity of Solid State Lighting (SSL) Products, ANSI C78.377-2017.

Electrical

Drivers:

Constant Current, Class 2, 550mA, 100-277V, 50-60Hz, 120V: 0.201A, 208V: 0.126A, 240V: 0.109A, 277V: 0.096A, Surge Protection: 6kV

Power Factor:

98.8% at 120V, 91.4% at 277V

THD:

12.6% at 120V, 16.4% at 277V

Dimming Driver:

0-10V dimming driver standard for ultimate flexibility. Use as on/off or utilize the 0-10V DC dimming circuit for controls.

Photocell:

Photocell is rated for 120V thru 277V. To disable, simply use the provide silicone rubber cap and cover.

Optical

BUG Rating:

B0 U3 G2

Construction

Ambient Temperature:

Suitable for -40°C (-40°F) to 40°C (104°F) ambient temperatures

Cold Weather Starting:

Minimum starting temperature is -40°C (-40°F)

Thermal Management:

Superior thermal management with die-cast aluminum heatsink

Housing:

Precision die-cast aluminum.

Refractor Lens:

High-impact, diffuse, UV-stabilized polycarbonate

Mounting:

Three (3) 1/2" NPS conduit entry points (2 sides for through-feed, and bottom), and drilling template for easy wall box mounting.

Reflector:

High-gloss white aluminum.

Gaskets:

High-temperature silicone gaskets

Finish:

Formulated for high-durability and long lasting color.

Green Technology:

Mercury and UV free. RoHS compliant components. Polyester powder coat finish formulated without the use of VOC or toxic heavy metals.

Other

Equivalency:

Equivalent to 70W Metal Halide/50W HPS.

Warranty:

RAB warrants that our LED products will be free from defects in materials and workmanship for a period of five (5) years from the date of delivery to the end user, including coverage of light output, color stability, driver performance and fixture finish.

Patents:

The design of WPTLED is protected by patents pending in US, Canada, China, Taiwan and Mexico.

FTC Country of Origin:

This product was assembled in the USA by RAB using imported components.

Technical Specifications (continued)

Other

Buy American Act Compliance:

This product complies with the Buy American Act.

Dimensions

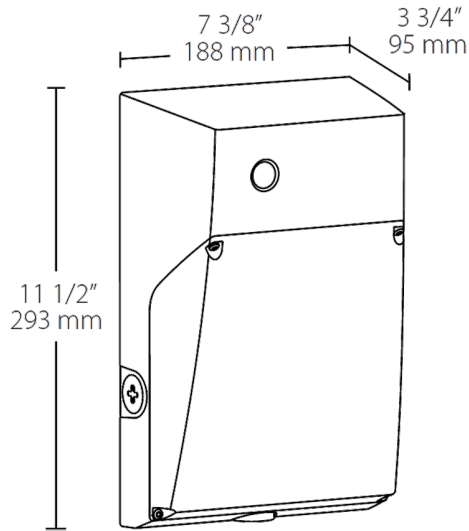

Features

- Covers footprints of most HID tallpacks
- 0-10V dimmable driver & 120 - 277V photocell
- Vandal-resistant lens
- 100,000-Hour LED lifespan

Ordering Matrix

Family	Wattage	Color Temp	Finish	Dimming	Photocell
WPTLED	25	N	W	/D10	/PC2
	12 = 12W 25 = 25W 40 = 40W	Blank = 5000K (Cool) Y = 3000K (Warm) N = 4000K (Neutral)	Blank = Bronze W = White	/D10 = Dimmable	/PC2 = 120-277V Photocell